

UNC Charlotte
Department of Art + Art History

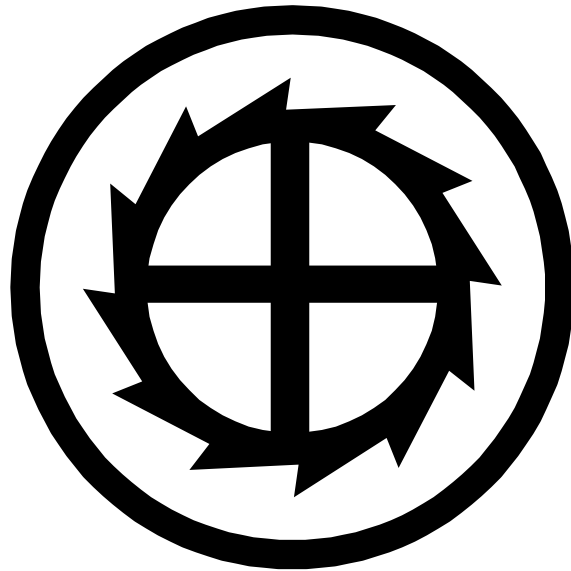

3D STUDIO
SAFETY MANUAL

The University of North Carolina Charlotte

Department of Art + Art History

Rowe Building

Table of Contents

ROWE 3D STUDIO	1
Golden Rules.....	2
Rowe 3D Studio Policies.....	3
General Studio Rules and Safe Practices.....	4
Personal Safety.....	6
Accidents.....	6
Understanding Studio Hazards.....	8
Know the Warning Signs.....	10
WOOD SHOP	11
General Terminology.....	11
Understanding Cutting Tools.....	12
Stationary Power Tools.....	14
Pneumatic Tools.....	25
Hand-Held Power Tools.....	28
Hand Tools.....	35
Measuring, Mark-Up, and Layout.....	40
METAL SHOP	41
General Terminology.....	41
Understanding Welding.....	43
Metal Shop Equipment.....	45
Pneumatic Tools.....	59
Hand-Held Power Tools.....	61
Hand Tools.....	64
STONE STUDIO	68
Stone Studio Equipment.....	68
FOUNDRY	75

Rowe 3D Studio



The Rowe 3D Studio offers students and faculty of the Department of Art + Art History facilities for wood working, metal working, stone carving, and metal casting.

It is the mission of the 3D Studio to foster an environment that stimulates the investigation of traditional object-making techniques, and experimentation with materials and methods. This is achieved by providing access to a wide range of tools and equipment, space to explore ideas, knowledgeable staff, and an inclusive environment that encourages dialog and collaboration across disciplines.

Students and faculty interested in exploring three-dimensional form and those seeking solutions for presenting two-dimensional and digital media are welcome to use the Rowe 3D Studio. A studio safety orientation is required for all users, during this orientation general studio policies are discussed, and instruction is given for much of the available equipment in our wood shop. Further instruction is provided for equipment and tools not covered during orientation as requested. Additionally, studio staff is regularly available to answer questions, brainstorm, and problem-solve.

GOLDEN RULES

1. Check in with the studio personnel when you are entering to work.
Sign in!
2. The 3D Studio is to be used for university projects only.
3. The studio is only to be used with proper supervision: studio manger, studio monitor, or class instructor must be present.
4. You must complete the studio orientation and pass the orientation test before using equipment.
5. Make sure all guests check in with the studio personnel and abide by all rules including wearing personal protective equipment, while in the studio. Guests may not work with the equipment.
6. Eye protection: safety glasses, goggles, or face shields are required to be worn at all times in the studio.
7. Proper ear protection should be worn at all times while equipment is running.
8. Foot wear: **Closed Toe Shoes Only!** No flip-flops, sandals, high heels, etc. are to be worn in the studio.
9. No loose clothing, hair, jewelry, etc.
10. Consider the safety of all students while working in the studio.
11. Report all accidents of any kind to studio personnel.
12. Do not operate tools while under the influence of drugs, alcohol or medication.
13. Always clean your work area and sign out before leaving the studio.

Rowe 3D Studio Policies

Access to the studio: Access to the studio and the use of equipment is limited to faculty, staff, and students currently enrolled in the Department of Art + Art History, who have completed a 3D Studio orientation, and passed the 3D Studio Manual Test. Upon completion of these requirements, a sticker will be placed on your UNCC ID designating you as a certified 3D Studio user. Certification is valid for one academic year (August-July) and must be renewed each Fall semester to maintain access to the Studio.

Certification Renewal: To renew 3D Studio certification you must re-take and pass the 3D Studio Manual Test. Additional orientations are not necessary for renewal. This can be done at any time of the year during hours that the studio is open.

3D Studio Orientations: Open orientations are available during the first 3-4 weeks of the Fall semester, and first 2 weeks of the Spring semester, a sign-up sheet will be posted outside the studio. Some classes will schedule private orientations during class time so check with your instructors before signing up for an open orientation. The 3D Studio orientation focuses on safe practices in the lab and most equipment in the wood shop only. Access to advanced woodworking equipment, metal shop, stone carving tools, and foundry will be granted after further training is provided by the Studio Manager or class instructor.

Training: To obtain training on advanced woodworking equipment, metal shop, and stone carving speak with the studio manager to arrange one-on-one time to review safe practices and proper use of this equipment.

Studio Hours: Studio hours vary each semester. Open hours will be posted on the Studio door by the second week of each semester. Summer hours may be limited to appointments only.

After-hours Access: Students enrolled in an Advanced Sculpture class may be given swipe-card access to the studio. **This access is not guaranteed by enrollment in Advanced Sculpture.** Students with swipe-card access must never work in the studio alone or with equipment that you have not received training on.

Guests: Uncertified guests are allowed in the studio only during monitored studio hours. Guests must check-in with studio personnel, abide by all studio rules, and may not use any of the equipment.

Food and Drink: No food or drinks are to be consumed in the 3D Studio.

Materials Use and Storage: Materials brought into the studio must be approved by the studio manager prior to their use. All chemicals must be clearly labeled and stored in proper containers (no reused food or drink containers). Space is limited in the studio, staff must approve storage. Materials left in the studio must be labeled with your name, year, and semester. All stored materials must be removed from the studio by the end of exam week each

semester, or other arrangements must be made with the studio manager prior to Winter or Summer breaks.

Revocation of Privileges: Access to the 3D Studio will be revoked for anyone who intentionally fails to comply with studio policies and/or jeopardizes the safety or well-being of other users or themselves. Reinstatement of privileges will be at the discretion of the 3D Studio Manager.

General Studio Rules + Safe Practices

1. Never use any type of tool for which you have not received specific instruction by the studio manager, studio monitors, or class Instructor on its proper and safe use, even if you have previous experience. You must know the tool's application and limitations, as well as the specific hazards of its operation before using any tool. If you are unfamiliar with any tools, ask one of the above personnel to assist you.
2. Keep work area clean. Cluttered areas and benches invite accidents. Keep book bags, extension cords and other supplies out of the walkways. Always be alert to other people in the area.
3. Do not perform set-up or layout with the machine running. Turn machines on only when ready to perform operation.
4. Never adjust the machine's settings with the tool running.
5. Familiarize yourself with the machine before using it. Always know where the on/off switch is. If an emergency situation arises, turn off the power first (if possible).
6. Always check machine settings before use. The previous user may have left the settings wrong or loose. Always reset the tool to its zero position when done.
7. Perform a dry run with the machine off after changing settings. Make sure that all adjustments are tight and locked, and that movement is free.
8. Use the right tool. Don't force a tool or attachment to do a job for which it was not designed.
9. Secure your work. Use clamps or a vise to hold the work when practical. It's safer than using your hand and frees both hands to operate the tool. A machine would rather throw material violently than cut or shape it unless it is firmly held in place.
10. Always hold the long side of the cut. Keep hands a safe distance from blades.
11. Both ends of material must be supported, even after the cut. The free end of a cut must not bind with the blade after the cut is made.
12. Do not cut small pieces with circular blades. Always keep hands at least 6" away from circular blades. Clamp small pieces or fashion a jig or hold-down. Otherwise, use hand tools to make cuts on small pieces.
13. Do not cut irregularly shaped, warped, or split materials with stationary tools. The material must sit flat against the tool's table and fence.
14. Do not cut wood containing nails or other foreign materials. Metal will dull wood-cutting blades instantly, cause sparks, and possibly be thrown as debris.

- 15.** Any spark producing operations must only be performed in the metal shop or outside court yard.
- 16.** Use caution when cutting through knots. Knots will often fragment unpredictably, turning into violent projectiles.
- 17.** Wear gloves when handling cut metal. The cutting process can make metal extremely hot and sharp burs can cut your hands.
- 18.** Do not start motors with the blade touching the material. Allow blades to reach full speed before beginning the cut.
- 19.** Make cuts with slow steady feed. Do not try to cut too quickly or abruptly. Always be prepared to stop the cut. Sudden movements invite a loss of control.
- 20.** Keep hands out of the cut path at all times. Always be aware of your hands in relation to the blade. Always be aware of the cut path.
- 21.** Always let machines come to a complete stop before removing scraps.
- 22.** Don't overreach. Keep proper footing and balance at all times. Do not reach over or across blades and moving parts. Do reach under machines that are on.
- 23.** Do not use dull or damaged blades. Stop cutting and alert shop personnel if cutting is difficult.
- 24.** Stop using tools that appear to be damaged or malfunctioning. Alert studio personnel. Never reconnect tools found disconnected without the permission of studio personnel.
- 25.** Reduce the risk of unintentional starting. Make sure switch is in "OFF" position before plugging in power cord.
- 26.** Never lean on tools. Serious injury could occur if the tool is tipped or if the cutting tool is accidentally contacted.
- 27.** Direction of feed. Feed work into a blade or cutter against the direction of rotation of the blade or cutter only.
- 28.** Never leave tool running unattended. Turn power off. Don't leave tool until it comes to a complete stop. Do not turn your back on running tools.
- 29.** Tools must be checked out by studio personnel for use outside of studio. You must leave your Student ID.
- 30.** No treated lumber allowed in the studio.
- 31.** No galvanized metal may be welded or torch-cut.
- 32.** Remove all metal from salvaged wood before working.
- 33.** Do not use any materials containing lead-based paints. If you don't know then you are responsible to test it.
- 34.** All stone work must be completed outside.
- 35.** Keep aisles and work area clean and clear.
- 36.** Store all flammable material in the flammable storage cabinets in room 107. This includes: paint, paint thinner, spray paint, acetone, wood finish, etc.

Personal Safety

Everyone using the 3D Studio is required to wear appropriate Personal Protective Equipment (PPE) while in the studio. This applies to those operating tools and equipment, and those who are in close proximity to these activities. Safety glasses, goggles, face shields, welding helmets, hard hats, ear plugs, ear muffs, dust masks, and gloves are available for use while in the 3D Studio. You may also bring your own PPE for use in the studio.



Eye Protection: Any activity that has the potential of creating flying debris, or puts you in a position that could cause your face to be poked requires the use of eye protection. Sun glasses and prescription eye glasses are not safety glasses. Goggles or face shields are recommended to be worn over prescription glasses. Prescription safety glasses with a legible ANSI marking on the lens and side shield in place are permitted. Activities that produce bright UV light such as welding or Oxy Acetylene cutting require shaded lenses combined with protection from heat and sparks. Welding helmets and shaded face shields are available.



Hearing Protection: Operations that produce loud noises or working in a room where loud noises are present require the use of ear plugs or ear muffs. Do not try to drown out the noise with headphones.



Respiratory Protection: Dust masks are required during heavy dust producing activities, such as grinding metal, stone, or wood. For the use of cartridge type respirators, a report of medical fitness must be filed with the Office of Environment Health and Safety (EHS) and training in proper use completed.

Hand Protection: Activities that produce hot surfaces such as welding or cutting metal require the use of nonflammable heat resistant gloves. Handling of hot and/or sharp material require the use of cut-resistant gloves. Caution gloves must not be worn while working with equipment that can entangle a loose-fitting glove.

Accidents

Any accident should be reported immediately and, if needed, first aid applied. First aid is the immediate, temporary care given the victim of an accident of sudden illness until the services of a physician can be obtained. First Aid kits are located in the wood shop and room 107, emergency eye wash stations are located in the metal shop and room 107.

A recent consideration in first aid care is **blood borne pathogens**. These include serious diseases such as the HIV virus that causes AIDS, and hepatitis B and C viruses.

To protect yourself, **Universal Precautions must be observed**. Universal Precautions mean treating all human blood/fluids as if it was infected, regardless of the person who is injured. If a blood spill occurs, notify the Instructor or Studio Supervisor immediately. Do not clean blood spills from tools, work areas, or the floor. Housekeeping is trained in proper sanitation methods for this and will perform clean-up of blood.

State of mind often contributes to minor and major accidents. Rushing, frustration, fatigue, and complacency are the cause of most critical errors that result in accidents or close calls.

Critical Errors: **Eyes not on work** – Looking away from your work for even a second can invite an accident.

Mind not on work – Carrying on conversations, checking on texts, running through to-do lists in your mind, etc. take your attention away from the task you are performing.

In the line-of-fire – Inadvertently putting yourself, or a part of your body in a position that exposes it to a hazard.

Loss of balance, traction, or grip – Failing to take the time to position yourself in a way that you have full control of tools and your work piece can cause serious injuries and make otherwise safe procedures extremely dangerous.

Change your attitude to avoid accidents:

Do not begin a project in the studio that you do not have adequate time to complete.

When you feel frustration coming on take a break from your work, it may be time to finish up for the day and come back tomorrow, or go for a walk to regroup.

Tiredness is as impairing as drinking alcohol or smoking pot. Do not come to work in the studio if you have not been getting adequate rest.

Experience and confidence do not make you immune to accidents. Every time you begin a task identify potential hazards of the operation and plan how to avoid them before beginning your work.

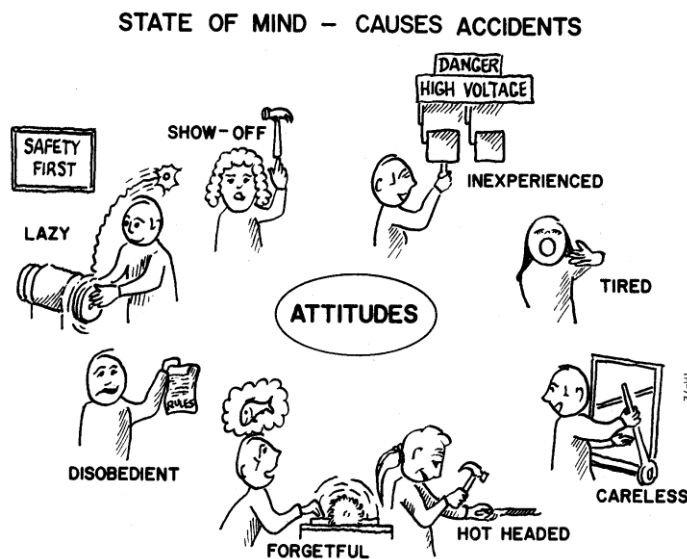

Understanding Studio Hazards

Power Tools

The most dangerous aspect of power tools is the moving parts. All of the stationary machinery in this studio is powered by electric motors, and the radial forces produced by spinning shafts, pulleys, blades, and belts can be particularly dangerous. This danger arises from two effects of spinning parts: **(1) outward forces**—work pieces and debris can become violent projectiles when thrown by spinning blades, and **(2) inward forces**—loose clothing, jewelry, hair, and fingers can be grabbed, wound up, pulled in, and mangled by any spinning machinery. Always be aware of the danger of these radial forces. Always wear eye protection, never stand in line with circular blades, and always maintain a safe distance from spinning parts when the tool is on. Gloves should not be worn while working in close proximity to spinning parts.

Electric Arcs

Electric arcs used for welding and cutting metal produce intense Ultra Violet radiation (UV), intense heat, and high voltage. Exposure to UV radiation will cause burns and eye damage. Repeated exposure can cause skin cancer. The intense heat generated by electric arcs will burn hair and flesh instantly. While working with an electric arc you are in close proximity to high voltage which could produce a potentially deadly electric shock. Always wear non-flammable clothing that does not leave skin exposed to UV radiation, footwear must be closed toe, non-flammable, and have a rubber sole. A full-face welding helmet must be worn with a #10 or greater shade to protect your face and eyes. Always properly ground your work piece before turning on an arc producing machine. Never operate an electric tool while standing in water or with bare feet.

Flames and Sparks

Processes that utilize flames and/or produce sparks must be done with extreme caution. Carelessly handling a lit torch can easily burn you, someone working nearby, or combustible materials near your work area. Small fires quickly become large fires when conducive conditions exist. Always ensure that your work area is clear of combustible materials and that those around you are aware that you will be working with an open flame. Check that firefighting equipment is nearby and operational before beginning work. Operations that produce sparks can also cause burns and start fires. Be sure that you and others are not in line with the spark spray. Sparks from welding can travel up to 40 feet. Only perform spark producing activities in the metal shop or outside after removing any combustible material from the area. Never sand, cut, or grind metal in the wood shop, an explosion could occur if sparks enter the dust collection system. Cold metal and hot metal look identical, wear gloves when processing metal in a way that will heat it up and mark hot metal as such so others in the area will not inadvertently pick it up.

Toxic Materials

Poisoning resulting from the ingestion or contact with toxic materials can present itself immediately or slowly over time. Even materials labeled as non-toxic can pose serious health risks if proper handling, use, storage, and clean-up is not strictly adhered to. Adhesives, stains, paints, and finishes used in wood working, fluxes, patinas, and cutting oils for metal working, stone polishing compounds, and fine dust from toxic metals and woods can all leave residue on tools and work surfaces in the studio. Always read and follow safety precautions on material labels. When handling toxic materials wear appropriate clothing and PPE, contaminated clothing should be removed when work is finished and cleaned appropriately before wearing again. Wash hands and exposed skin before eating, drinking, or smoking. Do not bring food and drinks into the 3D Studio. Report signs of poisoning immediately to studio personnel or class instructor. Sudden; headache, difficulty breathing, fatigue, nausea, fever, rashes, etc. are cause for concern and should be checked out immediately.

Airborne Particles

Cutting, sanding, grinding, etc. of wood, metal, and stone causes small particles (dust) to become airborne where it can be inhaled by those in the area that it is being produced. The hazard posed by airborne dust can range from a nuisance and mild irritant to extremely toxic leading to serious immediate and/or long-term health conditions. Dust producing operations must always be conducted in a way that minimizes exposure to inhaling dusts. Always operate woodworking equipment with the dust collection system on and appropriate blast gates open. Welding and cutting indoors must be done with the exhaust system on and vents positioned close to the operation. Heavy sanding and grinding of wood, metal, and stone must be completed outside. Dust masks should be worn while performing tasks that produce airborne dust that cannot be controlled with dust collection or localized exhaust systems. Tight fitting and/or cartridge type respirators require compliance with the UNCC Respiratory Protection Program. <https://safety.uncc.edu/sites/safety.uncc.edu/files/media/Respiratory%20Protection%20Program%20-%20July%202018v2.pdf>

Heavy Objects

Lifting, moving, and working with heavy objects, materials, and tools can cause injury in 2 ways. Improper lifting or handling techniques can cause strains and heavy objects can topple or be dropped causing serious injuries even death. Caution should be taken when working with heavy and/or large awkwardly shaped objects. Good posture should be used while lifting and moving heavy objects. Do not over estimate your strength, ask for help when moving large objects or use mechanical means to assist. When using hoists always ensure that chains and straps are secure and undamaged before lifting, lift slowly to see how a load will shift, and never stand or allow others to stand under a load while it is lifted.

Know the Warning Signs

All faculty, and students are expected to read, understand, and follow all posted instructions. In addition to instructional and policy signage, the equipment in the 3D Studio is marked with warning labels for specific hazards associated with the use of each machine. It is the user's responsibility to; look for, read, understand, and follow these warnings when using any piece of equipment in the studio. If you are unsure of specific safety protocol for a machine, ask for clarification before attempting to use it.

Warnings and graphics you may encounter



General Warning



Electric Shock/High Voltage



Electric Shock



Hand Entanglement/Gears



Hand Entanglement/Belts



Sharp Instrument



Hand Crush



Rotating Gears



Rotating Blade



Pinch Point/Moving Parts



Flying Debris



Flying Debris and Loud Noise



Corrosive Material



Hot Surface



Laser Beam



Ultraviolet Light



Toxic Material



Flammable Material



Oxidizing Material



Automatic Start-up



High Speed Moving Parts



Counter Rotating Rollers



Arm Entanglement



Body Crush



Foot Crush



Pressurized Cylinder



Arc Flash Explosion



Explosive Release of Pressure



Hot Liquid/Steam



Carcinogen

Wood Shop

General Terminology

Grain: The fibrous structure of the wood, evident in the light and dark streaking of the soft spring growth (light) and hard summer growth (dark) of the tree.

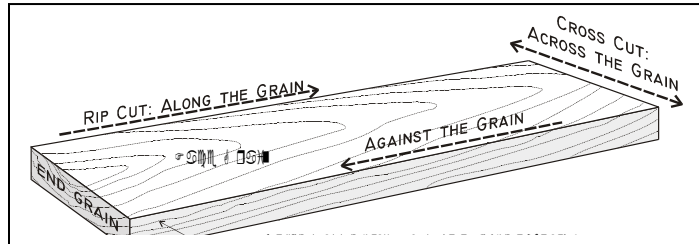

Grain figure: The pattern formed by the grain on the surface of a longitudinal cut (along the grain); the character of this pattern depends on the cross-section of the wood.

Knots: Areas of dense, twisted grain that occur where limbs branch apart (literal knots in the grain).

Softwoods: Wood of evergreen trees (not necessarily soft).

Hardwoods: Wood of deciduous or broad-leaved trees (not necessarily hard)

Milled lumber: Wood that has been processed (cut, planed, and sanded) into regular dimensions (also called stock).

Rip-cut: A cut in a board along its long dimension, with the grain.

Crosscut: A cut in a board across its short dimension, across the grain.

Kerf: The groove or cut made by a blade.

Miter: Refers to an angle; a miter joint is one in which both pieces are cut at an angle, and a miter gauge is a guide used hold the wood at a set angle.

Fence: The bar used to guide the wood along a straight path, or against which the wood is held when making a cut.

Butt joint: 90 degree joint in which the end of one piece abuts the side of another.

Hold-down: A simple clamping mechanism used to hold a piece of wood while cutting.

Jig: Any specially constructed mechanism used to facilitate a specific cutting procedure.

Blade Set: The alternating angled offset of the teeth of a blade.

Kickback: The sudden backward force produced when the blade stalls or binds in the wood during a cut.

Dado: A groove cut into a piece of flat wood.

Rabbet: A step cut into the end or edge of a piece of flat wood (a half-dado).

Molding or millwork: Shaped, decorative profiles cut into wood.

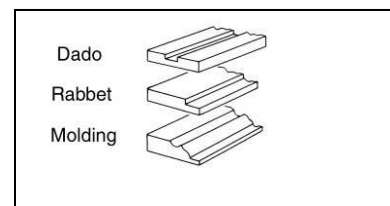

Understanding Cutting Tools

Understanding how saw blades cut will help you cut efficiently, accurately, and safely. There are two basic types of saw blades: the circular blade and the straight (or band) blade. The blade cuts wood with a series of sharp teeth along the cutting edge. Each tooth acts like a chisel that plows into the wood to make the cut, and these teeth are angled toward the direction that they rotate or slide. This is the direction that the force of the blade is exerted. The teeth point in the direction in which the saw will push the wood if allowed, or will throw debris.

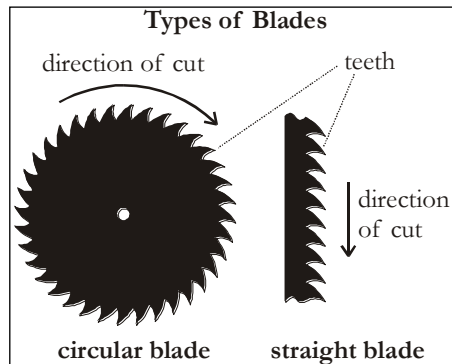

As one tooth cuts into the wood, it makes a path for the following tooth. As long as the cut is made properly, each individual tooth is required to remove only a small amount of wood. No significant friction should ever occur between the side of the blade and the wood. **If the blade and/or the wood is twisted or becomes misaligned, the side of the blade will foul out against the wood and create friction. This will cause one of three things to happen: (1) the blade will heat up and dull or break, (2) the blade will stall out and kickback, or (3) the blade will throw the wood.** If a blade begins to bind, ease off the cut and try to

correct the alignment. If the blade stalls out, hold the wood in place (or the saw in some cases) and turn off the motor. As you will not have time to react in the third possibility, preventive measures are critical. If the blade throws the wood, it will either throw it away from the machine—in which case you must not be in line with the blade—or it will pull the wood away from you toward the blade—in which case you do not want your hand too close as it will be pulled in after it. Wood that is irregularly shaped, warped, or split parallel to the cut will be prone to move as it is cut, creating a dangerous situation. Cutting through knots is also hazardous, as they are dense and brittle. When cut, knots can fragment unpredictably, creating debris that can become violent projectiles. When cutting, a slow steady feed should be used. If excessive force is required, the blade is dull or not appropriate for the material being cut. Forcing a cut will overheat the blade and create the potential for it to bind in the wood. The thickness of the blade, including any side-to-side offset of the teeth, is called the blade's set and determines the width of the slot or groove cut into the wood. This groove is known as a kerf, and generally measures between 1/16 and 1/8 inch. This groove is waste material, and must be taken into account for when marking a board for cutting.

Every blade is designed to cut a specific kind of material and to make specific kinds of cuts. Using a blade to cut the wrong kind of material can result in damage to the blade and injury to the operator. **Circular blades can only be used to make straight cuts. Never try to make a curved cut with a circular blade.** Straight or band blades can cut both straight and curved cuts. Blades designed to cut wood generally have larger teeth, and blades for metals and plastics have small teeth. Never try to cut metal with a wood cutting saw, and cut plastics only under

direct supervision. Never cut wood that *might* contain nails or other foreign materials. Metal will instantly dull a wood cutting blade and potentially create hazardous debris. The size of the teeth also determines the thickness of wood that can be cut with a blade. Blades with large teeth are used to cut thick wood; those with small teeth cut thin wood. Generally, it is not advisable to cut wood that is thinner than the space between a blade's teeth. This is true because the larger teeth tend to splinter and grab the thin wood instead of cutting it cleanly. Blades with small teeth can overheat and warp when cutting thick wood, so care must be taken when doing so. The size of the teeth of a blade is described in terms of the number of teeth, either as the number of teeth per blade in the case of circular blades, or teeth per inch in the case of straight blades.

Another characteristic important to straight blades is the width of the blade. The width of the blade determines the kinds of curves that can be cut with it. The more narrow the blade, the tighter the curve possible. Wide blades can only make straight or gently curving cuts,

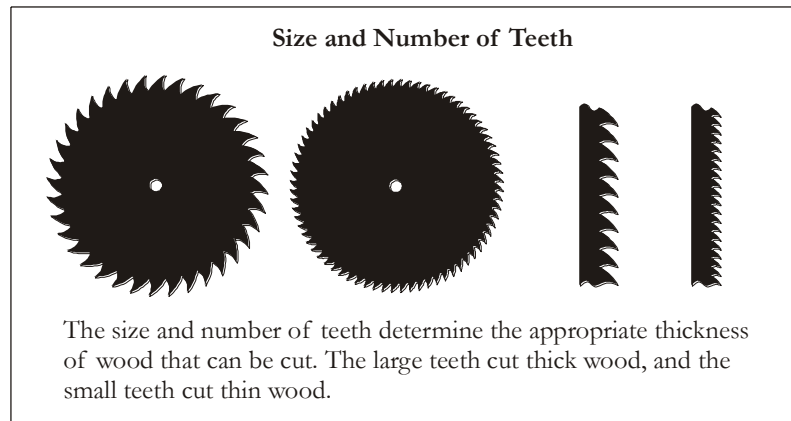

whereas a very narrow blade can make very tight curves with a small radius. If the blade binds up during a curved cut then the blade is too wide to make the turn. Trying to force a blade to curve too tightly will wear out the blade and the blade guides very quickly, potentially breaking the blade.

The grain of the wood will also affect the cut. **Wood cuts more cleanly along the grain than across the grain.** Crosscuts often result in the splintering and tear-out of the wood fibers along the trailing edge of the cut. As the blade's teeth emerge from the wood, they tear the fibers rather than cut them off cleanly. Softwoods and veneers are most susceptible to tear-out. Blades with fine teeth cause less tear-out than coarse teeth. This tear-out can be minimized by making the cut slowly, especially as the blade cuts through the wood. Having a sacrificial board on the underside of the cut also helps, or taping the area to be cut beforehand. If practical, cut outside your guideline and later sand down to the line. Most importantly, use sharp, well-maintained blades appropriate for the material.

Listen to the sound of the machine as it cuts, and be aware of any changes in pitch as the cut progresses. You will usually hear the motor begin to strain if the blade begins to bind, even before you see or feel it. If you hear the machine having trouble, ease off and re-correct, or stop the cut. Try to identify the problem before proceeding.

Pay attention to the results of the cut. Watch for undue tear-out, splintering, or especially scorch marks on the cut surfaces. Scorch marks mean that friction is producing enough heat to burn the wood.

These marks indicate that the blade is fouling out, the blade is dull, or the blade is not appropriate for the material. Be aware that woods with heavy resins can gum the blades and cause excessive friction. If the cut ever begins to smoke, stop the cut immediately and correct the cause before proceeding.

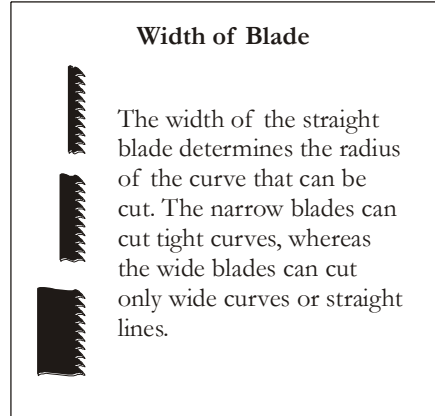

Stationary Power Tools

Circular Saws

Special care must be taken with tools that cut with a circular blade. These blades cut with tremendous forces, and the radial motion of the blades can both throw wood and debris outward and pull fingers and loose clothing inward. The wood being cut must be held securely at all times. If allowed, the blade will try to move the wood violently rather than cutting it.

Table Saw

STRICTLY OFF LIMITS WITHOUT MANAGER TRAINING AND APPROVAL

Configuration - Circular blade mounted into table.

Cutting Action - Wood is moved across tabletop either against fence or pushed with miter gauge. **NEVER CUT FREEHAND**

Adjustments - Blade can be raised and lowered
- Blade can be tilted to the right 0/45° for bevel cuts

Cuts - Straight cuts Rip cuts (along board's length) with fence
- Cross-cuts and miter cuts on short boards with miter gauge
- Dado and mill work with fence



- Safety:**
- Wood must be flat and straight, free of splits, warping, or foreign objects (metal)
 - Always operate with blade guard or riving knife in place
 - Always use the rip fence for rip cuts or miter gauge for cross cuts
 - Never use the rip fence in combination with the miter gauge
 - Adjust blade height to 1/8" above the wood to be cut
 - Stand to one side of the blade. Never reach across a moving blade
 - Keep hands out of the line of cut
 - Use a push stick to maintain 4" distance of hands from blade
 - Push wood completely past blade to complete a cut
 - Never back up once a cut has begun (hold wood in place and stop the machine if a cut must be stopped part-way through)
 - Wait for blade to stop before removing scraps
 - If someone is assisting to cut larger boards, the assistant must not pull or direct the cut in any way

Compound Miter Saw (Chop Saw)

Configuration - Circular blade mounted on single action arm

Cutting Action - Blade swings down in chopping motion
- Wood is held in place while blade is moved

Adjustments - Compound Miter Saw blade swivels for miter cuts
- Compound Miter Saw blade tilts for bevel cuts

Cuts - Crosscut and miters in long narrow boards
- Compound Miter Saw cuts compound miters in long narrow boards

Safety

- **Firmly affix wood against table and fence: never cut freehand**
- **Hold wood with left hand, cut with saw in right hand**
- **Keep hands 4" from blade. Use hold downs when necessary**
- **Slow steady feed: DO NOT TRY TO CUT TOO QUICKLY**
- **Tilted blade bevel cuts are most prone to binding and thus most dangerous**
- **Always return saw to its full start position after the cut**
- **Never "gang cut" Never cut more than one piece at a time**



Sliding Compound Miter Saw

Configuration - Circular blade mounted on a double action arm

Cutting Action - Slides forward above wood swings down in chopping
- Motion then slides back on rails, cutting on the push stroke
- Rail assembly can be locked so that saw can only chop like a standard miter saw
- Wood is held in place while blade is moved



Adjustments - Blade assembly swivels for miter cuts $45/0\backslash45^\circ$
- Blade assembly tilts for bevel cuts $45/0\backslash45^\circ$
- Depth of cut can be set for dado cuts

Cuts - Straight cuts
- Compound crosscuts and miter cuts in long boards

Safety - **Firmly affix wood against table and fence: never cut freehand**
- **Hold wood with left hand, cut with saw in right hand**
- **Slow steady feed: DO NOT TRY TO CUT TOO QUICKLY**
- **Tilted blade bevel cuts are most prone to binding and thus most dangerous**
- **Always return saw to its full start position after the cut**
- **Never "gang cut" Never cut more than one piece at a time**

Panel Saw

Configuration - Circular blade mounted to carriage that slides on rails

Cutting Action - Carriage slides from top of frame to bottom to complete cross cuts
- Carriage is locked and wood is fed through for rip cuts



Adjustments - Depth of cut is non-adjustable
- Carriage can be locked on rails and blade turned 90° to make rip cuts

Cuts - Straight cuts in large panels

Safety - **Wood must sit flat on rollers and be supported on both sides of cut**
- **Slide blade all the way to the bottom of rails, release trigger, and then return blade to top of rails before moving stock**
- **Keep hands and feet out of line with the cut**
- **Never "gang cut" Never cut more than one piece at a time**

Straight Bladed Saws

Although straight bladed saws such as the band saw are somewhat safer than circular saws, misuse can still result in serious bodily injury. Band saws are generally more versatile than circular saws, and they are able to make many of the same kinds of cuts as well as others. Unlike circular saws, cuts on band saws can be made free hand (without fence or miter gauge) as long as the pieces are given adequate and stable support throughout the cut. This means that curved cuts can be made as well as straight. However, the band saw does not cut as precisely as a circular saw and cannot cut dados and rabbets.

20" Band Saw

Configuration - Long, continuous band blade looped around large upper and lower wheels

Cutting Action - Wood is moved on table into blade

Adjustments - Table top tilts for beveled cuts 0\45°

Cuts

- Straight cuts and wide curves
- Rip-cuts, crosscuts, miters, re-saws, and long radius curves in medium size boards and panels
- Curves are cut freehand
- Rip-cuts are cut with fence
- Crosscuts and miters are cut with miter gauge

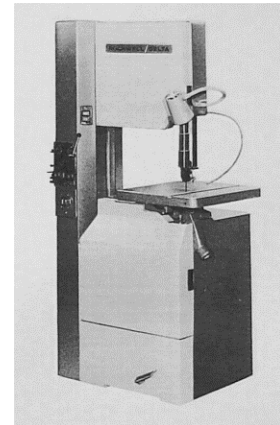

Safety

- **Wood must lay flat against table and be held stable**
- **Keep hands and fingers out of the line of cut, use push sticks when necessary**
- **Take extra care when cutting through knots, and when the blade is exiting the stock at the end of the cut. WATCH YOUR FINGERS, ESPECIALLY AT THE END OF THE CUT**
- **Never cut round or unstable wood without secondary support (such as a jig). The downward force of the blade will twist round or unstable stock as it cuts, causing the blade to bind, kink, and break**
- **Set guard no more than 1/4" above wood**
- **Never force a curved-cut tighter than allowed by the blade width**
- **Back out of short cuts slowly with the motor running, stop and realign the cut if the blade pulls with the wood**
- **Stop the saw to back out of long cuts (over 6"). Backward pressure can cause the blade to jump its guides, hang up, and break**
- **Plan your cuts before you begin cutting. Make sure the wood will clear the throat throughout the cut. Make release cuts before cutting long curves**

14" Band Saw

Configuration - Long, continuous band blade looped around large upper and lower wheels

Cutting Action - Wood is moved on table into blade

Adjustments - Table top tilts for beveled cuts 0\45°

Cuts

- Straight cuts and wide curves
- Rip-cuts, crosscuts, miters, and long radius curves
- Curves and rip-cuts are cut freehand
- Cuts any size piece of wood that will fit through throat and fit on table
- Crosscuts and miters are cut with miter gauge

Safety

- **Set guard 1/8"-1/4" above wood**
- **Same as 20" Band Saw**
- **Watch your fingers**



Scroll Saw

Configuration - A short thin blade held through the table by a long arm

Cutting Action - The blade reciprocates up and down, cutting on the down stroke

Adjustments

- The table tilts for bevel cuts
- The blade can be easily removed and inserted through a hole in the wood to allow trapped cuts

Cuts

- Intricate and delicate curves in flat, thin wood

Safety

- **Watch your fingers**
- **Make sure blade has teeth pointing down**
- **Make sure tension is adjusted properly on the blade**
- **Do not push too hard on wood. You want only enough pressure to maintain good contact on the down stroke, not the up stroke.**



Tips for Band Saws

- The width of the blade determines the minimum radius that can be cut. Wide blades are appropriate for big curves and smaller blades will cut tighter curves.
- Many jigs can be used with band saws. Miter gauges, rip fences, circle cutting jigs, etc.
- Band saws do not produce a smooth cut surface. When cutting leave your pencil line then sand to the line.
- Listen to the saw. If the noise from the machine changes adjust how you are feeding the material.

Sanders

The large stationary sanders are used primarily for shaping and coarse sanding. These sanders remove material very quickly and must be used very carefully. Deep gouges can be quickly cut into the wood surface, and edges can easily be sanded crooked. Always hold your work piece securely, and sand with light, even pressure, moving the piece constantly. Use the tables and guides whenever practical, and a straight or beveled edge is required. Trying to sand too quickly will result in poor accuracy and sloppy work.

The primary danger of power sanders is that the users underestimate their hazard because there are no blades. They can however be just as dangerous as saws. **The hazards of power sanders include (1) the radial forces of the spinning parts, (2) the abrading power of the sanding surfaces, and (3) the fine particles of dust created.** Power sanders have been known to pull out hair by the roots and tear flesh away to the knuckles. Wood dust can be extremely flammable, and the dust created from sanding lead-based paints and other materials can pose long term health risks to both the operator and others in the area.

Rules for power sanders

- **Never leave sanders running unattended.**
- **Always maintain secure footing around the sander.**
- **Never wear gloves, loose clothing, jewelry, neckties, or long loose hair near sanders.**
- **Never lean over or reach under running sanders.**
- **Never power sand metals, including nails, screws, or other fasteners in the wood shop. Sparks can ignite air borne sawdust. Countersink fasteners below wood surface before sanding.**
- **Never power sand painted wood or other materials in the 3D Studio.**
- **Always run dust collector when sanding.**

Oscillating Spindle Sander

Configuration - A cylindrical sanding spindle mounted in a table

Action - The spindle spins and oscillate up and down. Wood is kept in contact with the table while concave surfaces are sanded. NOT INTENDED FOR FLAT SURFACES.

Adjustments - Interchangeable spindles of various diameter

Safety

- **Keep material flat against the tabletop**
- **Use light pressure. Do not burn out the sandpaper.**
- **Tie back long hair and secure loose clothing and jewelry**
- **Do not wear gloves**
- **Select the spindle that is closest in diameter to the curve you are sanding**



Belt/Disk Sander

Configuration - Combination belt and disk sander

Action - Rough sands and shapes

Adjustments - Belt swivels from horizontal to vertical. DO NOT CHANGE WITHOUT PERMISSION OF SHOP PERSONNEL

- Tables tilt 0\45°
- Miter gauge can be used

Safety

- **Hold wood firmly, always be able to hold against the direction of sander**
- **Never approach from attacking angle**
- **Be aware of belt tracking and tension. Shut off machine and alert shop personnel if belt tracks wrong, especially if sparks are created**
- **Do not use if belt or disk is loose or torn. Alert shop personnel**
- **Keep hands away from abrasive surfaces, especially near intake gaps**
- **Use tables to support material when sanding against a vertical belt or disk**
- **Hold wood securely. Loose wood will be thrown violently**
- **Do no stand in line with out feed of belt. Do not let others stand in line of the out feed (Horizontal configuration)**
- **Never sand pieces too small to hold safely**
- **Never use gloves or a rag to hold material**
- **Use sanding disk on down side, not up side**
- **Sand with the grain whenever possible**
- **Keep work moving. Do not over sand in one place**

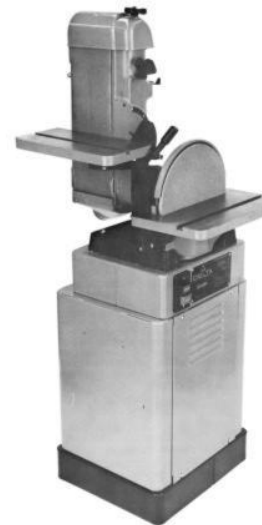

Oscillating Edge Sander

Configuration - long oscillating belt sander

- Action
- Smooths long flat surfaces up to 36"
 - Rounded end can be used for concave curves
- Adjustments
- Belt swivels from horizontal to vertical. DO NOT CHANGE WITHOUT PERMISSION OF SHOP PERSONNEL
 - Tables move up and down to expose fresh abrasive
 - Sanding drums can be attached
 - Miter gauge can be used



- Safety
- **Always use tables to support workpiece**
 - **Hold wood firmly, always be able to hold against the direction of sander with at least 1 finger behind the board**
 - **Only for sanding board in their long dimensions**
 - **Never approach from attacking angle**
 - **Be aware of belt tracking and tension. Shut off machine and alert shop personnel if belt tracks wrong, especially if sparks are created**
 - **Do not use if belt is loose or torn. Alert shop personnel**
 - **Keep hands away from abrasive surfaces**
 - **Hold wood securely. Loose wood will be thrown violently**
 - **Do not stand in line with out feed of belt. Do not let others stand in line of the out feed**
 - **Never sand pieces too small to hold safely**
 - **Never use gloves or a rag to hold material**
 - **Do not sand circles**
 - **Keep work moving. Do not over sand in one place**

Shaping

Besides general cutting and sanding tools, there are many other tools used for specialized shaping, such as jointing edges, planing surfaces, and cutting molding. For the most part, these power-shaping tools are some variation of a cutter blade (composed of knives or blades mounted on a spindle or shaft) and a guide surface or surfaces. Such tools include the jointer, the planer, and the router. With the lathe, the wood is spun on spindles and the cutting instruments (the chisels or turning knives) are held stationary. Hand shaping is performed with a variety of chisels, knives, rasps and files, as well as small all-purpose devices such as the Dremel and rotary cutter.

The safety procedures for the shaping tools are essentially the same as those for the circular saws. Keep in mind, however, that the knives on the shaper cutters are generally much larger than the teeth of the saw blades and they for are more prone to grab loose clothing and throw large splinters.

Jointer

STRICTLY OFF LIMITS WITHOUT MANAGER TRAINING AND SUPERVISION

Configuration - A series of short knives mounted on a horizontal spindle set into a long flat table equipped with a fence.

Action

- The jointer is used to true the edges of boards, that is make them very straight at a constant angle to the face.
- The wood is pushed on the table along the fence and into the spinning knives.

Adjustments

- Blade elevation
- Out-feed table height
- Fence can be tilted for beveled edge

Safety

- **Studio personnel must supervise you when using jointer.**
- **Use push blocks and push sticks to feed wood through cutters.**
- **Be aware of where your fingers and hands are placed when using the jointer.**
- **Keep in feed and out feed table clean and clear of debris.**



Thickness Planer

OFF LIMITS WITHOUT MANAGER TRAINING, AND SUPERVISION

Configuration - A series of 15-inch knives mounted on a horizontal spindle set above a short table and equipped with self-feeding rollers.

Action

- Planer is used make the faces of a board flat and parallel.
- The wood is fed between the spinning roller/knife assembly and the table.

Adjustments - Table or blade elevation for thickness

Safety

- **Shop personnel must supervise you when using planer.**
- **Wood must be free of all dirt or any metal and paint.**
- **Ear protection when using the machine.**
- **Remove only a maximum 1/16 of an inch at a time.**



Router Table

OFF LIMITS WITHOUT MANAGER TRAINING AND SUPERVISION

Configuration - Router mounted upside-down in a table with a fence.

Action - The router is used to “mold” the edges of boards, that is shape them into specific molding profiles.
- The wood is pushed on the table along the fence or with the miter gauge and into the spinning knives.

Adjustments - Interchangeable cutters for different profiles
- Blade elevation
- Fence settings

Safety - **Do not use without specific permission, training, and direct supervision.**
- **Detailed safety protocol is given during training.**
- **Always feed wood into the rotation of the cutter.**
- **Use push blocks when necessary to maintain safe distance between cutter and hands.**
- **Secure loose clothing, jewelry, and long hair. Do not wear gloves.**



Wood Lathe

OFF LIMITS WITHOUT MANAGER TRAINING AND SUPERVISION

Configuration - Two spindles equipped with a parallel tool rest.

Action - The lathe is used to “turn” or cut rectangular pieces into cylindrical forms.
- The wood is mounted between the spindles and spun, while turning chisels are used to cut cylindrical profiles.

Adjustments - Spindles accommodate various lengths
- Variable speed
- Adjustable tool rest
- Variety of chisels

Safety - **Do not use without specific permission, training, and direct supervision.**
- **Detailed safety protocol is given during training.**
- **Secure loose clothing, jewelry, and hair. Do not wear gloves.**
- **Face shield is required to be worn while working on the lathe.**
- **Tool rest must be used with chisels, gouges, and scrapers.**



- **Tool rest must be removed when sanding.**

Power Drills

The principle danger of power drill is the loss of control by the operator and the danger of loose material being twisted up onto the bit. Remember, the bit is spinning, creating the hazards of radial forces.

Floor Drill Press

Configuration - Overhead drill mounted above adjustable table

Cutting Action - Drill bit is mounted in a chuck, which travels up and down on the quill
- Drills holes perpendicular to table

Adjustments - Variable speed
- Table elevation
- Quill can be locked
- Depth stop for setting hole depth

Safety

- **Use only bits appropriate for the material.**
- **Make sure that the bit is tight and straight in chuck.**
- **Remove key from chuck before turning on.**
- **Secure wood, clamping it whenever possible.**
- **Do not drill into metal table.**
- **Place a scrap of wood under work to avoid tear-out.**
- **Check drill speed: faster for soft materials or small bits, slower for hard material or large bits.**
- **Never use auger bits in the drill press.**
- **Avoid awkward hand positions in which a sudden slip would cause hand to go into the cutting tool.**
- **Hold work in left hand and operate drill with right hand.**
- **Never wear gloves, neckties, jewelry, loose clothing, or long loose hair.**



Drill Bits

These examples are just a few of the many bits available. It is important to note which bits are appropriate for what materials. In general, wood cutting bits can be used only to cut wood, whereas metal cutting bits can cut both metal and wood. Any bit that has a sharp center point is only to be used on wood.

- A. **Countersink:** creates an enlarged hole with an angled bottom to allow screw heads to set below the surface
- B. **Combination Bit:** a flat tapered bit with a shoulder for drilling and countersinking holes for wood screws
- C. **Forstner Bit:** a very precise bit for cutting large holes over ½ inch
- D. **Masonry Bit:** a bit for drilling holes into masonry, cement, or stone
- E. **Brad-Point Bit:** a woodcutting bit with a sharp point that reduces point drift and cuts a hole with a flat bottom (also called a bullet-point bit)
- F. **Reduced Shank Twist Bit:** a large twin-fluted bit with a smaller shaft
- G. **Twist Bit:** a twin fluted bit with a beveled point appropriate for general drilling in wood or metal
- H. **Spade Bit:** a flat, inexpensive bit for boring large holes over ½ inch wide. Not accurate and tend to tear-out the beginning and ends of cuts
- I. **Auger:** drills large deep holes with a brace or slow speed hand drill. The threaded point screws into the wood and pulls the bit deeper. IT CANNOT BE USED IN THE DRILL PRESS.
- J. **Fly Cutter:** an adjustable hole saw. IT CANNOT BE USED WITH A HAND DRILL, AND CAN ONLY BE USED IN THE DRILL PRESS.
- K. **Hole Saws:** for sawing large holes (1 to 3 inches) through wood no thicker than twice its length (3-½ inches max)

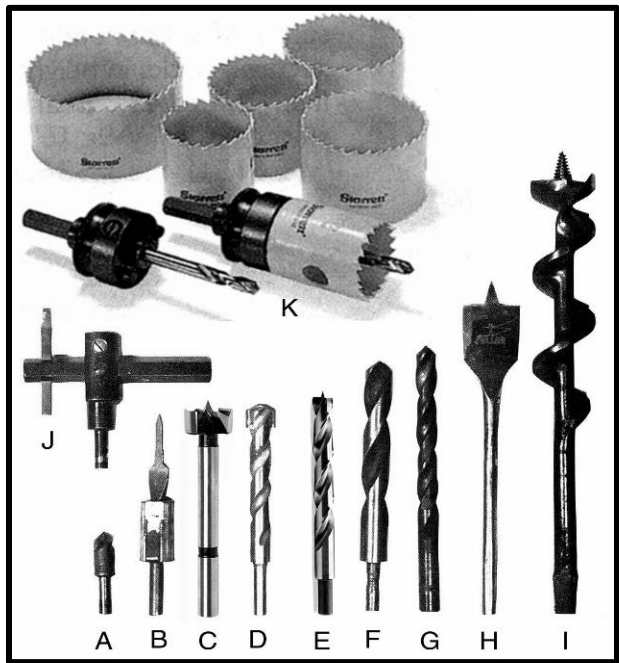

Pneumatic Tools

Pneumatic tools are powered using compressed air and must be connected to the shop's air supply. Compressed air lines are installed throughout the studio in the form of hoses. Air hoses use a female fitting that will connect to the male fitting on the tools. Before use of the tool, the tool should be oiled with proper air tool oil. Air pressure is regulated by valves at each hose connection point. The air pressure is set at 90 psi (pounds per square inch), this is appropriate for most tools used in the studio. If you change the pressure for a specific task, be sure to return the pressure back to 90 psi when you are finished. Never exceed 120 psi in the 3D Studio for any reason.

18 ga. Brad Nailer

Configuration - Pneumatic 18 gauge

Nailing Action - Used only to fasten wood

Adjustments - Nails vary from 5/8" to 2"
- Nail depth

Loading - Clips must be pulled back and nails must be placed in with heads up

Safety

- **Always wear eye protection.**
- **Keep all body parts a safe distance away from the area of nailing.**
- **NEVER POINT THE NAIL GUN IN THE DIRECTION OF OTHERS.**
- **Avoid nailing in areas of knots, metal, and/or other hard areas in the wood.**
- **Always have nailer pointed against the wood when nailing.**



16 ga. Brad Nailer

Configuration - Pneumatic 16 gauge

Nailing Action - Used only to fasten wood

Adjustments - Nails vary from 1" to 2 1/2"
- Nail depth

Loading - Clips must be pulled back and nails must be placed in with heads up

Safety

- **Always wear eye protection.**
- **Keep all body parts a safe distance away from the area of nailing.**
- **NEVER POINT THE NAIL GUN IN THE DIRECTION OF OTHERS.**
- **Avoid nailing in areas of knots, metal, and/or other hard areas in the wood.**
- **Always have nailer pointed against the wood when nailing.**



Narrow Crown Stapler

Configuration - Pneumatic 18 gauge

Nailing Action - Used only to fasten wood (not for paper or fabric)

Adjustments - Staples vary from ¼" wide by ½" to 1 ½" long
- Staple depth

Loading - Tool is held upside down to open magazine and insert staples

Safety

- **Always wear eye protection.**
- **Keep all body parts a safe distance away from the area of nailing.**
- **NEVER POINT THE NAIL GUN IN THE DIRECTION OF OTHERS.**
- **Avoid stapling in areas of knots, metal, and/or other hard areas in the wood.**
- **Always have stapler pointed against the wood when nailing.**



Framing Nailer

Configuration - Pneumatic nailer

Nailing Action - Used only to fasten wood together

Adjustments - Nails vary from 2" to 3 ¼"

Loading - Clips must be pulled back and nails must be placed in with heads up

Safety

- **Always wear eye protection.**
- **Keep all body parts a safe distance away from the area of nailing while in use.**
- **NEVER point the nail gun in the direction of others.**
- **Avoid nailing in areas of knots, metal, and/or other hard areas in the wood.**
- **Always have nailer pointed against the wood when nailing.**



V-Nailer

Configuration - Pneumatic nailer for fastening miter joints

Nailing Action - Used only to fasten wood miter joints

Adjustments - v-nails vary from ¼" to ¾" long
- Stop guides for nail-joint alignment

Loading - Tool is held upside down to open magazine and insert nails
*Be sure nails are facing the correct direction

Safety

- **THIS NAILER HAS NO BUILT-IN SAFETY. Extra care is needed**
- **Always wear eye protection.**
- **NEVER POINT THE NAIL GUN IN THE DIRECTION OF OTHERS.**



Nails for Pneumatic Nailers



18ga. Brad Nail



16ga. Finishing Nail



18ga. Narrow Crown Staple

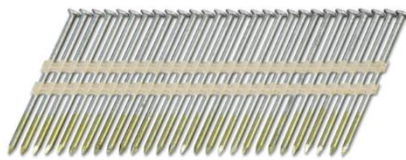

Framing Nail

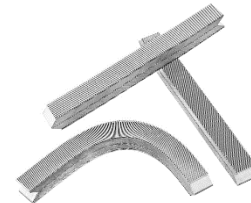

V-Nail

These are the types of fasteners you will find in the 3D Studio for use with pneumatic nailers. Each nailer accepts only 1 type of fastener. Incorrect nails or improperly loaded nails will jam the nailing mechanism and may permanently damage the tool. Properly loaded fasteners should move freely in their track when inserted and little effort should be needed to close magazines.

Disc Sander

Configuration - Handheld high-speed disc sander

Action - Disc spins at high speed to rapidly remove material

Disc Requirements - 4 ½" disc with back-up pad
- Discs available for wood, metal, and stone

Safety

- **Safety glasses, dust mask, and ear protection are required.**
- **Sand at proper angle to avoid breaking the disc. Torn discs can throw sharp pieces violently.**
- **Be aware of loose clothing and material.**
- **Item in which you are sanding must be properly clamped or held down**



Die Grinder

- Configuration
- Hand held rotary grinder
 - Straight shaft and 90° variations
- Action
- Uses different bits for many different grinding purposes
- Bit Requirements
- Use the proper bit for the material
 - Bits are available for wood, metal, and stone



- Safety
- **Safety glasses, dust mask, and ear protection are required.**
 - **Be aware of body parts near grinding bits.**
 - **Be aware of loose clothing and material.**
 - **Item in which you are grinding must be properly clamped or held down.**

Grinding Bits

These are examples of the most common die grinder bits that you may encounter in the 3D Studio. It is important that you choose the appropriate bit for the material you are grinding. Using the wrong bit for the material will result in destroying the bit, your work piece, and possibly causing the bit to break apart throwing sharp fragments back at you or others.

- A. Rotary Rasp:** For filing and shaping wood, these bits are recognizable by their black-oxide finish and large cut burs facing in one direction.
- B. Carving Burs:** For carving and shaping hard wood. These bits feature sharp spikes that are designed to remove wood quickly. The coarsest burs have large spaces between the spikes resulting in fast removal of material and a rough finish, while the spikes on fine burs are densely packed resulting in smoother finished surfaces. These bits should not be used in soft or resinous woods because they will clog.
- C. Carbide Burs:** These bits are for metal only. They are recognizable by their bright silver or gold color and long serrations (double-cut have a diamond pattern). These burs remove material quickly and leave a smooth finish.
- D. Grinding stones:** Composed of man-made stone attached to a metal shank, these bits are for grinding metal. Grit is indicated by color. Do not use grinding stones on aluminum.
- E. Diamond Burs:** Steel shanks of different shapes are coated with industrial-grade diamonds. Only use to grind stone, ceramic, or masonry.

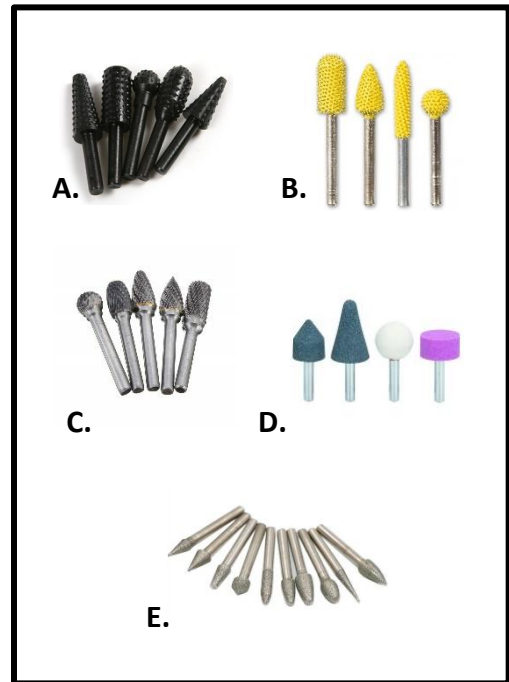

Hand-Held Power Tools

The 3D Studio maintains a large inventory of hand-held power tools. These tools often seem less intimidating than stationary power tools but they must be treated with the same respect given their larger counterparts. Hazards posed by hand-held power tools include those introduced by radial forces as well as exposure to blades and cutters, airborne dust and debris, and loss of control due to loss of grip and/or footing. Before connecting a hand-held power tool to a power source inspect the tool for damage to blades/cutters, guards, housings, and power cords. If damage is found, or the tool malfunctions stop using it immediately and report it to studio personnel or class instructor. To avoid accidental start-up, be sure that power switches are in the off position before plugging tools into a power source. Do not obstruct walkways with power cords.

Circular Hand Saw

USE ONLY UNDER DIRECT SUPERVISION

Configuration - Hand held circular blade

Cutting Action - Wood is held in place while blade is moved

Adjustments - Blade can be raised or lowered for cut depth
- Blade tilts for bevel cuts 0/45°

Cuts - Straight cuts
- Rips-cuts and crosscuts on stock too large to fit on table saw or miter saw

Safety

- **Set blade depth so that the teeth emerge completely from underside of cut.**
- **Keep the blade aligned along straight path. Make sure you don't bind the blade.**
- **Never cut "blind." Always ascertain that underside of cut is clear of obstructions.**
- **Do not cut into tabletop or supports.**
- **Make sure both sides of the cut are supported even after the cut is made.**
- **Do not cut electrical cord.**
- **Allow blade to stop spinning before placing saw down after cut is finished.**
- **Take extreme care when making bevel cuts, as the angle between the blade and foot can bind the blade easily.**
- **Always hold saw with both hands.**
- **Secure small and/or thin work with clamps. The wood must not be allowed to move during the cut.**



Jig Saw

Configuration - Hand held saw, with a short stout blade extending from bottom (foot)

Cutting Action - The blade reciprocates up and down, cutting on the up or down stroke depending on blade

Adjustment - Varies with model
- Trigger can be locked on
- Speed can be adjusted
- Single action or orbiting blade
- The foot tilts 45° on some models

Cuts - Straight or curved cuts in moderately thin wood (up to length of blade)

Safety - **Do not cut “blind”. Do not cut without ascertaining backside of cut is clear of obstructions.**
- **Do not cut into tabletop or support.**
- **Do not cut electrical cord.**
- **Keep electrical cord free of snags.**
- **Make sure blade extends completely through material throughout stroke**
- **Secure material before cutting. Small and/or thin material may flex or vibrate causing loss of control.**



Reciprocating Saw

Configuration - Hand held saw, with a stout blade extending from end

Cutting Action - The blade reciprocates in and out, cutting on the in stroke

Adjustment - The shoe is both hinged and removable
- The blade can be reversed
- Variable speed

Cuts - Freehand rough cuts (up to length of blade)

Safety - **Do not cut “blind”. Do not cut without ascertaining backside of cut is clear of obstructions.**
- **Do not cut into tabletop or support.**
- **Do not cut electrical cord.**
- **Keep electrical cord free of snags.**
- **Make sure blade extends completely through material and beyond shoe throughout stroke**
- **Secure material before cutting. Small and/or thin material may flex or vibrate causing loss of control.**
- **Use both hands to hold the saw.**

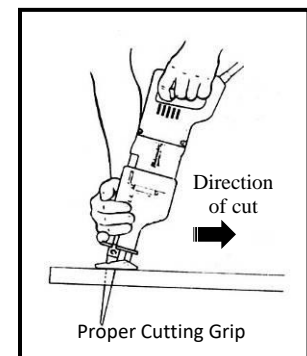

Hand Drill

Configuration - Hand-held drill

Action

- Work is secured and drill moved by hand
- Can be used to drive screws with special bits
- Hammer action for hard masonry and stone (some models only)

Adjustment

- Trigger can be locked on
- Speed can be adjusted by varying pressure on trigger
- Forward and reverse directions

Safety

- **Do not drill “blind”. Do not drill without ascertaining backside of work is clear of obstructions.**
- **Secure loose clothing, jewelry, and long hair.**
- **Do not drill into tabletop or support.**
- **Keep electrical cord free of snags.**
- **Use both hands on drill. If the bit binds up, the drill will try to wrench itself violently from your grip.**



Cordless Drill

Configuration - Hand-held drill

- Similar to the hand drill, but battery powered and used primarily for driving screws. Cordless drills are often equipped with a clutch that slips when the screw is seated, preventing the head from being broken off or stripped out.

Action

- Work is secured and drill moved by hand
- Hammer action for hard masonry and stone (some models only)

Adjustment

- Speed can be adjusted by varying pressure on trigger
- Forward and reverse directions

Safety

- **Do not drill “blind”. Do not drill without ascertaining backside of work is clear of obstructions.**
- **Secure loose clothing, jewelry, and long hair.**
- **Do not drill into tabletop or support.**

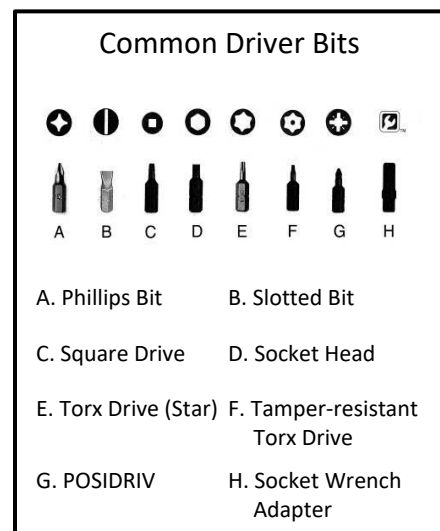

Dremel

Configuration - A small, all-purpose shaping/cutting device similar in configuration to the pneumatic die grinder



Action - Uses rotary bits for light shaping, grinding, and cutting in wood, metal, plastics, and stone

Adjustments - Variable speed
- Can be fitted with various attachments for specific purposes

Bit Requirements - 1/8" shank
- Bits are available for wood, metal, and stone

Safety - **Be aware of body parts near grinding bits.**
- **Be aware of loose clothing and material.**
- **Item in which you are grinding must be properly clamped or held down.**

Flex- shaft Rotary Tool

Configuration - A small, all-purpose rotary shaping device
- Motor and light-weight hand piece are connected by a flexible shaft
- Excellent for fine detail



Action - Uses rotary bits for light shaping and grinding in wood, metal, and stone

Adjustments - Variable speed controlled by foot-pedal

Bit Requirements - 1/8" shank
- Bits are available for wood, metal, plastics, and stone

Safety - **Be aware of body parts near grinding bits.**
- **Be aware of loose clothing and material.**
- **Item in which you are grinding must be properly clamped or held down.**

Rotary Tool Bits	
A – E	High speed rotary cutters: for general purpose shaping of wood, metal, or plastics.
F – H	Tungsten carbide cutters: longer lasting cutters for metal
I	Wire brush: for cleaning corrosion and rust on metals
J – M	Grinding points: for grinding metal
N	Cutting disks and Mandrel: for cutting metal

Router

OFF LIMITS WITHOUT SPECIFIC PERMISSION, TRAINING, AND SUPERVISION

Configuration - High-powered hand held motor with base plate
 - Accepts rotary cutters with 1/4" or 1/2" shanks

Action - The router is used to cut slots, dados, and to shape the edges of boards
 - The wood is secured and the router is moved by hand

Adjustments - Interchangeable cutters (bits) for different cuts and profiles
 - Bit depth
 - Various guides, jigs, templates, straight edges, and accessories for specific Procedures



Safety - **Do not use without specific permission, specific training, and direct supervision.**
 - **Secure wood to bench or table with clamps when necessary. Wood must not move while routing.**
 - **Be sure power switch is in off position before plugging in the tool.**
 - **Always move the tool against the direction of rotation.**
 - **Always hold the tool with two hands**
 - **Avoid cutting through knots**
 - **Do not use chipped, cracked, or bent bits**

Router Bits

Router bits come in a variety of shapes and profiles, each suited for a particular kind of cut. There are two types of router bits (1) plunge and (2) bearing. Plunge bits are used to cut in the center area of a board, whereas a bearing bit cuts around the edges.

Common Router Bits	
A-Bull Nose	B-Round Over
C-Cove	D-Roman Ogee
E-Ogee	F-Beading Bit
G-Chamfer	H-Rabbit
I-Straight (dado)	J-Trim Bit
K-V-Groove	L-Dovetail
M-Round-nose	N-T-Slot
O-Slot-Cutter	P-Piloted Cutter
Q-Glue Joint	R-Laminate Trimmer
S-Pilot Bearings	

Hand-held Sanders

All of the same precautions taken with the large stationary sanders also apply to the smaller hand-held sanders, especially the belt sander. The finishing and random orbit sanders, however, produce far less force and are thus generally safer. Always wear a dust mask when sanding, especially when there is not a dust collector on the machine. Heavy sanding operations must be completed outside. **NEVER SAND WOOD PAINTED WITH LEAD-BASED PAINT.** Special hazardous materials precautions must be taken with the dust produced from sanding lead-based paint. If you cannot determine with absolute certainty that a paint is not lead-based, treat it as if it were.

All hand sanders are equipped with trigger locks that lock the sander in the on position. Make sure the lock is off before plugging in the sander.

Some hand sanders are equipped with dust collecting bags. Always check these bags before and after use, and empty any dust inside.

Hand Belt Sander

Configuration - Small, hand held continuous belt

Action - Belt rotates around two pulleys; sander is moved while wood is held stationary

- Safety
- Use both hands to hold the sander firmly.
 - Secure the wood. The sander will throw loose wood.
 - Never approach from attacking angle. Do not tear the belt on sharp corners.
 - Be aware of belt tracking and tension. Shut off machine and alert studio personnel if belt tracks wrong, especially if sparks are created.
 - Do not use if belt is loose or torn.
 - Keep hands away from abrasive surfaces, especially near intake gaps.
 - Do not sand electrical cord, loose clothing and/ or cloth in the sanding area.



Quarter Sheet Palm Sander (Finishing Sander)

Configuration - Small, hand held vibrating pad sander. Accommodates a quarter sheet of sandpaper.

Action - Sanding pad vibrates in a back and forth motion.

- Safety
- Keep hands and power cords away from abrasive surface.
 - Take frequent breaks to avoid numbness in hands.



Random Orbit Sander

Configuration - Small, hand held rotating pad sander. Accommodates Adhesive-backed discs.

Action - Sanding pad vibrates in a randomly changing circular motion

Safety

- **Keep hands and power cords away from abrasive surface.**
- **Take frequent breaks to avoid numbness in hands.**
- **Secure long hair, loose clothing, and jewelry.**



Sandpaper

Most of the sandpaper you will need for power sanders and hand-sanding is provided by the 3D Studio. It is your responsibility to acquire specialty abrasives on your own. Each hand-held sander requires a different type and shaped sandpaper, studio personnel will assist you in selecting and loading the correct abrasive for the job. Keep in mind sandpaper is expensive and should not be discarded before it has fully reached the end of its effective life. Used sandpaper is collected in a box labeled as such so it can be re-used.

Sandpaper is graded by “grit”, which references the size of the abrasive particles. Low numbers (24...60) indicate a coarse grit, these are best for the heavy removal of material and finishes. Higher number (220...400+) indicate a fine grit and should be used for finish sanding.

The sanding process smooths wood by creating successively smaller scratches. Therefore, sanding should be completed in stages for best results,

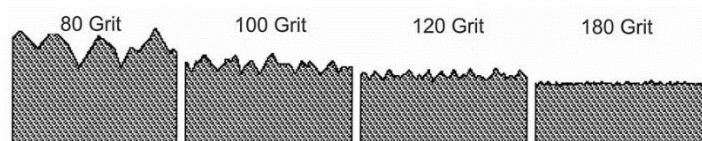

beginning with a coarse grit and working up to a fine grit. Always sand in the direction that the grain is running to not tear wood fibers, sanding across the grain creates marks that are not easily repaired and often indicate poor craftsmanship.

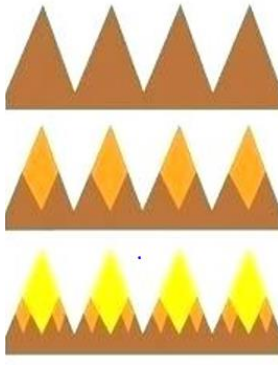
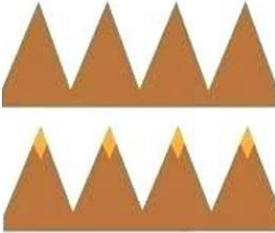
CORRECT SANDING	INCORRECT SANDING
 <p>First Cut Initial sanding with coarse grit creates deep scratches.</p> <p>Second Cut Medium grit paper removes the deep scratches created by the first cut, leaving shallower scratches.</p> <p>Third Cut Fine grit paper removes the scratches left by the second cut. The resulting scratches which are shallower still, leaving a surface that appears smooth.</p>	 <p>First Cut Initial sanding with coarse grit creates deep scratches.</p> <p>Second Cut Medium grit paper is skipped jumping to fine grit paper. Only the tops (peaks) of the deep scratches are removed. The result is a rough surface.</p>

Hand Tools

Hand tools play a very important role in studio safety. Large and irregularly shaped objects that cannot be safely maneuvered on stationary equipment, or secured for use with hand-held power tools will require the use of hand tools. The 3D Studio maintains an extensive inventory of hand tools, this manual will highlight those that are most commonly used in the studio.

Hand Saws

Few tools are as useful or as often overlooked or misused as the handsaw. When used correctly, the handsaw is a quick and efficient way accomplishing precise cuts. When misused, the handsaw is tiresome and sloppy. The hand saw should be used any time a power tool would be difficult or dangerous to use.

Correct use of a handsaw:

A hand saw must be sharp to be useful. A dull saw will quickly tire the user after very little progress. If a saw is dull, either replace the blade (if possible), or inform studio personnel. You will also find sawing much easier when the saw is held correctly. The work should be secured at a comfortable height, with the saw, your wrist, elbow and shoulder in line. The saw should be held at a 45-60° angle to the wood for general cutting, and level for precise cutting, with your elbow bent. You will want to stand so that you can look down at the saw on edge and in line with the cut. The saw should appear to be just a thin line, and you should be able to see both sides of the saw with only a slight movement of your head. When you make a stroke, you should be able to keep the saw's cutting edge level without seesawing the end up and down. The motion should be smooth, steady, and comfortable. If not, reposition the work or your body. Remember to cut on the waste side of your mark.

Hold the saw with a relaxed but secure grip, with your index finger pointing forward. This finger will help provide lateral control. To start a cut, begin with a few short strokes, steadying the saw with the thumb of your free hand. Be careful that you don't let the blade hop off the work and cut your hand. After a groove is started, continue sawing with long steady strokes. Long, even strokes are more efficient, producing a faster cutting action and better control. A short, jerky motion will wear out both you and the saw. You must not tense up your hand, arm, or body, especially as you begin to fatigue. You should concentrate on using only those muscles needed for steady control. Use just enough force to maintain contact with the wood. If you tense up or force the cut, you will upset the saw's balance, resulting in a crooked and uneven cut. A well-tuned saw will want to cut straight: let it. Concentrate on keeping the saw straight in line and level, not on cutting fast. Cutting through hard parts, such as knots, will require slower—not faster—strokes. Support the waste end until the cut is complete. Letting it fall off by itself will cause the work to split. Also, do not twist the saw to knock the waste piece away, as this will damage the saw's teeth.

Each kind of saw is designed for a specific task. Using the wrong saw for any task means wasted effort and poor accuracy.

A. Bow Saw: A large, double-action toothed band blade is held in tension like a bowstring. It is used for cutting limbs and rough lumber

B. Rip, Crosscut, or Panel Saw: General-purpose saws. The teeth configuration determines whether the saw is appropriate for ripping, crosscutting, or sawing panels.

C. Back Saw: A straight wide blade stiffened along the top edge for accuracy and that cuts on the push or “back” stroke. It is used for cutting miters (often with a miter box), tenons, and dovetails.

D. Gent Saw: A smaller version of the back saw used for very precise work

E. Coping Saw: A saw with a narrow, thin blade (cuts on the pull stroke) held in tension by a deep C-shaped arm. It is used for cutting intricate curves. The blade can be inserted through a hole in the piece to make a trapped cut.

F. Hack Saw: A saw with a fine-toothed band saw blade held in tension. It is used for cutting metals and some plastics. The blade cuts on the push stroke.

G. Flush-cut Saw: an extra thin, flexible blade that cuts on the pull stroke. It is used to cut wooden dowels and pins flush without marking the surface. Also useful for various detail cuts.

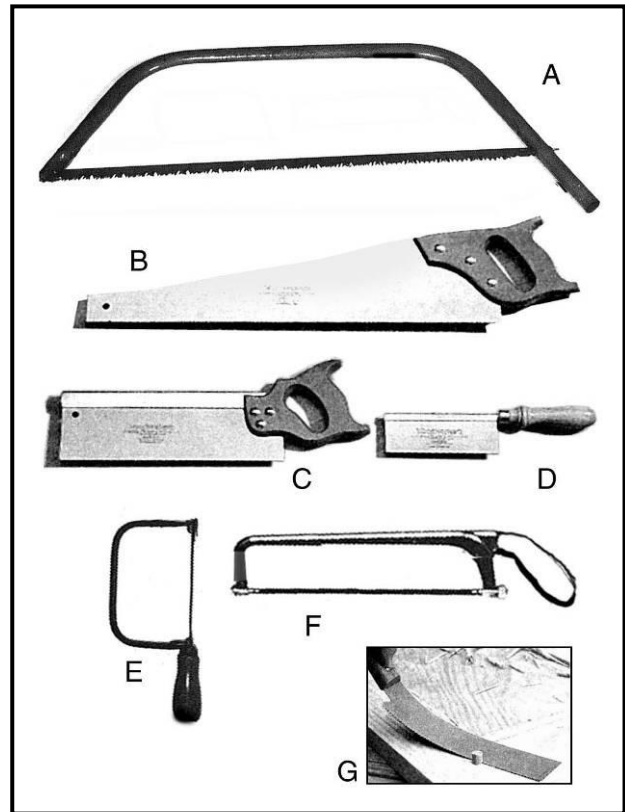

Miter Box: a box or jig that guides the back saw when making miter cuts.

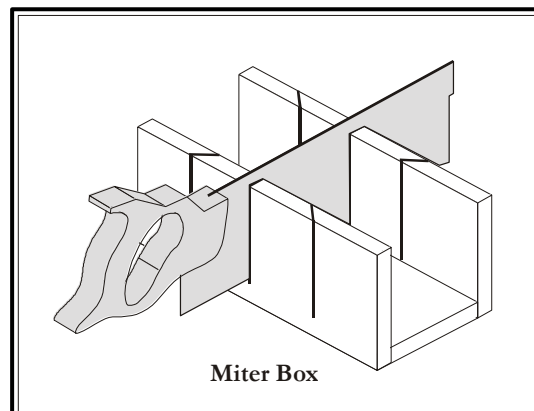

Hammers

A hammer is a very basic tool for any studio. Hammers are made of various materials and shapes suited for specific tasks. Whether you are driving nails, striking a tool, or aligning parts during assembly it is important to adhere to hammer safety protocols.

Safety - Use the proper size and type of hammer for the job.

- **Wear eye protection, wood can splinter, nails can break, and hammers themselves can even shatter throwing debris in all directions.**
- **Never throw a tool.**
- **Check the head to see that it is securely fastened to the handle. If not, notify studio personnel. DO NOT USE THE TOOL**
- **Common hazards are; smashing thumbs and fingers, fumbling and dropping, being hit on the head during the back swing.**



A. Claw Hammer (curved) - light-weight (13oz-16oz), for driving and pulling nails.

B. Claw Hammer (straight) - heavier (16oz-32oz), for driving large nails and prying boards.

C. Ball Peen Hammer - used for driving nails, pins, and dowels, the ball end can be used for shaping metal.

D. Soft-face Hammer - has the weight of a ball peen but the non-marring faces will not damage the materials being struck.

E. Rubber Mallet - a fairly light-weight mallet with a rubber head that will not damage materials.

F. Rawhide Mallet - A very light-weight mallet with a large head made from a roll of rawhide. Good for delicate work and forming soft metals. Do not use for striking tools.

G. Dead Blow Mallet - heavy duty non-marring hammer, good for assembling large tight fitting parts, the head is filled with lead shot that helps transfer power from the mallet to material while minimizing bounce-back.

H. Wooden Mallet - as the name suggests a mallet made from hardwood, good for striking carving tools and assembly.

I. Carving Mallet - for striking carving tools and chisels that have plastic or reinforced wooden handles, the round head directs all of the force from each blow to the point of contact. It also allows the user to continually turn the tool thus extending the life of the tool.

J. Cross Peen Hammer - a heavy duty hammer for driving spikes, large pins, or shaping metal, the pointed end is designed to concentrate all of the force from the hammer to a small area to amplify its impact. Use slow swings with this hammer, let its weight do the work.

K. Sledge Hammer - a heavy hammer with a handle as long as an axe. Used for demolition or moving heavy parts.

Screwdrivers

When selecting a screwdriver, remember the tip should fit snugly in the slot and be almost the full width of the screw head. Most hardware is supplied with either slotted or Phillips screws. To drive screws, it takes downward pressure to keep the tip in the slots. The Phillips screwdriver is very much like the slotted screwdriver. The difference is that the tip is shaped like an "x" so it will fit into slots in Phillips screws.

There are two ways to size a screwdriver. The length of the blade is one size. Tip sizes are another way to size and are numbered #1 - #4. The most common size is #2 tip. Each tip fits a certain range of screw sizes.

- Safety** - Use a screwdriver only for its intended use, not as a punch, wedge, or pry bar.
- Do not use a screwdriver with a broken handle, bent blade, or a dull twisted tip.
 - Keep your hands away from the work after the screw is started.
 - Never hold an object in the hand and press a screwdriver into it.

Chisels & Gouges

Wood chisels and gouges cut and shave wood. They are differentiated by the shape of the cutting edge: a chisel has a flat cutting edge, while a gouge has a curved or angled cutting edge. Each can be used for general shaping and carving, some are designed for specific joinery techniques such as cutting mortises or finishing the interiors of dove-tail joints.

Chisels and gouges are made of a steel blade heat treated throughout so it can be sharpened its entire length. Chisel sizes are determined by the width of the blade. Blades are available from 1/8" to 1", and in 1/4" increments from 1" to 2". Gouges are identified by their size and shape of the cutting edge.

Chisels and gouges are made to either cut by hand or cut by holding the chisel and striking it with a hammer or mallet. Tools with plastic handles that are reinforced with a steel button on the end can be struck with metal hammers. Tools with all plastic handles or wooden handles reinforced with a ferrule (metal ring on the end) can be struck with wooden or plastic mallets. Tools with all wooden handles cannot be struck with any kind of mallet or hammer. Whether striking or pushing the tool, the beveled side should be turned down. This enables you to control the depth of cut.



- Safety**
- Keep chisels sharp. A sharp tool is less dangerous than a dull one because less pressure needs to be used.
 - Drive chisels outward, away from your body.
 - Never put your hand in front of the cutting edge.
 - Remove nails or screws from the wood before you use a chisel on it.
 - Never use a wood chisel as a pry or wedge. The steel is hard and brittle and may break.
 - Always carry a chisel with the sharp end pointed down

Planes

There are many different types of wood planes, each designed for different purposes. The most common function of a plane is to flatten and smooth boards. The 3D Studio has several planes for this purpose: Block-Planes are small general purpose smoothing planes, they are especially useful for working on the edges of boards. Jack-Planes are larger planes that can be used to flatten the wide face of a board.

Configuration - A wide flat blade mounted to a stout body

Adjustments - Depth of cut

Action - Wood is held stationary, the tool is pushed across its Surface



Block Plane



Jack Plane

How to use a Block Plane

- First rest the palm of the hand to be used on the upper-most part of the plane; then grasp the sides of the plane between the thumb and second finger with the index finger resting in the hollow of the finger rest at the front of the plane.
- Pressure should be applied down and forward at the beginning of the stroke.
- Maintain uniform pressure throughout the stroke.

NOTE: ALWAYS PLANE WITH THE GRAIN. IF THE GRAIN IS IRREGULAR, IT MAY BE NECESSARY TO CHANGE THE DIRECTION OF PLANNING TO SUIT THE RUN OF THE GRAIN. IF CROSS OR CURLY GRAIN IS TO BE CUT, BE SURE THAT THE PLANE EDGE IS VERY SHARP AND SET FOR A FINE CUT. WHEN ANY PLANE IS NOT IN USE, SET IT ON ITS SIDE TO PROTECT THE BLADE.

Safety

- **Secure wood with clamp, vice, or bench-stop.**
- **Be mindful of the sharp cutting edge when making adjustments.**

Measuring, Mark-Up, and Layout

The 3D Studio has a wide variety of tools to aid in marking, layout, and measuring. When measuring for cuts, remember that blades have thickness and will turn a portion of the wood into sawdust. Cut on one side (waste side) of pencil mark, in some cases it is best to cut right up to your pencil line then sand or file the rest of the way. This approach is useful when cutting on the band or scroll saws.

“Measure twice and cut once.” When unsure, cut a little long and physically check fit.

Tools for layout:

1. **Pencil** (*not shown*)
2. **Scribe** any kind of sharp, pointed metal marking tool. Because a pencil mark is not as thin as a scratch or knife cut, a scribe mark is more precise.
3. **Tape measure**
4. **Square** L-shaped, right-angle metal straight edge
5. **Combination Square** an adjustable 90 degree and 45 degree angle gauge with a ruler on one side and an offset that can be set against the edge of a board for accuracy on the other
6. **Compasses** marks circle around a center point
7. **Marking gauge** an adjustable scribe that slides along the edge of a board to mark a set distance from that edge
8. **Bevel** an adjustable gauge for transferring variable angles
9. **Calipers** two prong measuring device similar to a compass (*from left to right: inside calipers, outside calipers, dividers*)
10. **Chalk line** a chalk impregnated string on a reel for snapping straight lines
11. **Plumb bob** a pointed weight on a string used for determining true vertical
12. **Level** a rigid straightedge with bubble gauges for determining true vertical and true horizontal.
13. **Speed Square** a triangular right angle with a T-shaped edge that can hook on to the edge of a board. Can also be used for marking angles.

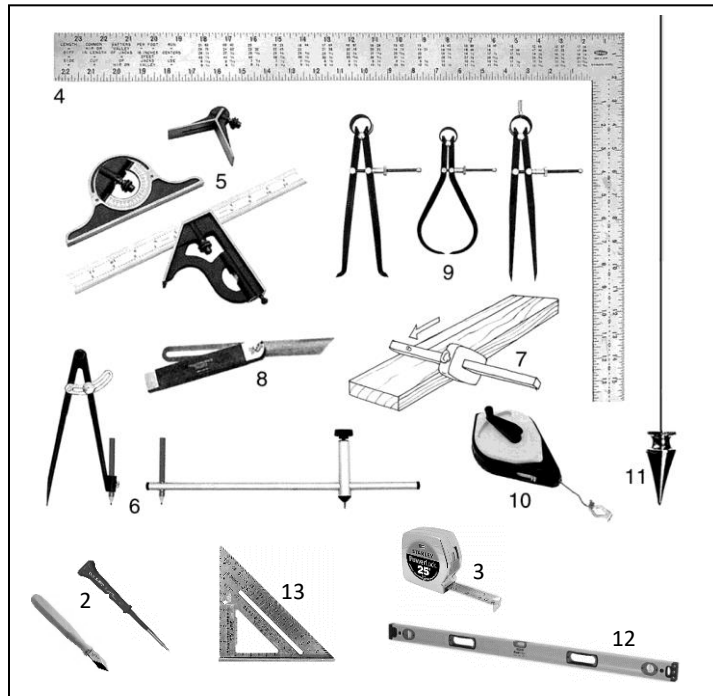

Metal Shop

The metal shop in the 3D Studio is equipped for cutting, welding, bending, and machining various types of metal. The tools and equipment used in the metal shop pose many of the same safety risks as those in the wood shop with some additional hazards. Electric shock, toxic fumes, pressurized gas cylinders, and intense heat are the primary hazards unique to the metal shop.

This space is not included in the 3D Studio Safety Orientation. Students and faculty interested in using the metal shop must complete Metal Shop Training with the Studio Manager, or an instructor authorized by the Studio Manager to provide training.

General Terminology

Steel: an alloy of iron and carbon

Hot Rolled Steel: refers to the process used to manufacture the steel. Steel is rolled/formed into sheets, bars, rods, etc. while the material is red hot, this produces a finished steel that is relatively soft and malleable, making it easy to drill, cut, and shape.

Cold Rolled Steel: is manufactured in a similar way to hot rolled steel except the forming process takes place when the steel is cold. This produces a finished material that is very hard. It is more difficult to cut and drill, and must be heated to bend. It is a good choice for parts that will be subject to a lot of wear.

Work Hardened: repeated bending and hammering on metal will compact the material's crystal structure, making the metal hard to drill, cut, and bend.

Annealing: the process of heating and cooling a metal in a way that "opens up" the metal's crystal structure, making the material more malleable.

Bar/Rod: long thin solid pieces of steel are referred to as bars or rods. Furthermore, the bar's width and shape determine its name (1/2" square bar or 3/4" round rod).

Tubing: is any long hollow piece of metal used for structural applications, tubing can come in any shape (round, square, rectangular, etc.). Tubing is measured by its actual outside dimensions (OD).

Pipe: is always round and is used in industry as a vessel for fluids and gasses. It is specified by Nominal Pipe Size (NPS) and Schedule (wall thickness). NPS is not an exact measurement but it corresponds somewhat closely to the pipes inside diameter (ID). Schedule refers to the wall thickness and as the schedule number increases the wall thickness increases. For example schedule 40 pipe has a wall thickness of .133" while schedule 80 is .179".

Plate: refers to flat pieces of metal. Typically, plate is sold in 4'x8' and 5'x10' pieces.

Bur: is a small razor sharp edge of metal left on the back side of a cut (similar to tear-out). These should be removed with a file or grinder.

Arc: is electricity "jumping" between two objects, it produces a bright light and intense heat.

Direct Current (DC): an electric arc where the energy is moving in one direction (from the positive pole to the negative pole).

DC+: the welding electrode is the positive pole, electricity begins at the electrode and flows into the work piece.

DC-: the welding electrode is the negative pole, electricity flows from the work piece to the electrode.

Alternating Current (AC): electricity flows in both directions.

Electrode: the part of a welder that conducts electricity. In some processes the electrode melts to serve as the filler metal, while in other applications the electrode does not melt.

Weld: the process of heating 2 similar metals to their melting point and fusing them together.

Brazing: the process of joining 2 metals by adding filler metal only (the base metal does not melt).

Soldering: essentially the same as brazing except the filler metal melts at a lower temperature (below 840°F).

Filler Metal: metal added to a weld to compensate for; gaps in the materials, material lost during the heating process (welding only), and to reinforce joints. In brazing and soldering this is the metal that binds the base metals.

Tack Weld: a small weld intended to temporarily hold pieces together.

Flux: a chemical that cleans the area where 2 metals are to be joined. Flux simultaneously keeps impurities out of the area and aids in the flow of molten metal.

Understanding Welding

Welding steel is the most common activity in the metal shop, whether you are welding yourself, or working alongside others who are welding, having a basic understanding of the process will help you identify the hazards that are present and work safely in the space.

Types of Welding

Welding is the process of joining two pieces of similar metals by heating them to a molten state and fusing them together. There are two basic types of welding: gas welding (Oxy/Acetylene), and electric arc welding. Gas welding employs a flame to heat the base metals while the operator adds filler metal to the welded joint to add strength to the union and replace any material lost in the process. Electric arc welding melts the base metal with the heat of an electric arc generated by a controlled short circuit, filler metal is introduced by a consumable electrode. In both techniques the molten metal is kept clear of atmospheric impurities by either a shielding gas or the smoke cloud of “burning” flux.

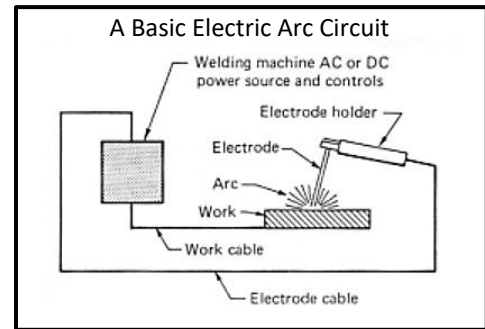

Electric arc welding is further divided into two basic types; arc welding or “Stick welding” and metal inert gas welding (MIG). Both processes work on the same central principles with the key differences being the electrode and the flux. In stick welding the electrode comes in the form of a short rod coated in flux, this rod melts along with the flux during welding and needs to be replaced often. MIG

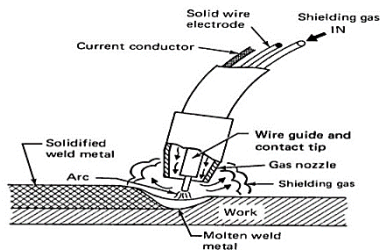

MIG Welding

welders use a spool of wire in place of the rod, the wire is fed at a user-determined rate to supply filler metal in a way that eliminates the need for constant stops.

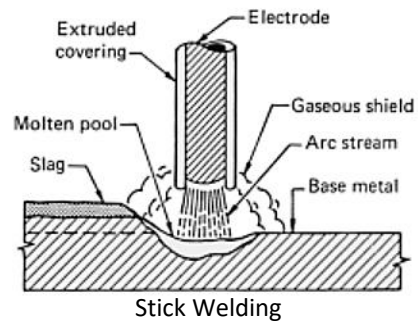

Stick Welding

Flux comes in the form of a mixture of CO² and Argon gases that acts as a shield over the molten metal.

Welding Hazards

All welding exposes the operator and those working nearby to several hazards. The intense heat created by an electric arc reaches near 7,000° F, hot molten metal can be thrown from the weld area (spatter), and the welded object, tools, tables, etc. can retain heat for a long time after welding has stopped. Therefore, the welder must wear protective clothing; leather gloves, a long sleeved shirt or jacket made of either heavy cotton or leather, long pants, closed toe/closed back shoes with rubber soles, and spats to cover fabric (tennis) shoes.

The electric arc also produces strong Ultra Violet radiation in the form of bright light that within a second of exposure will “sunburn” eyes potentially causing permanent damage. Welders must wear a welding helmet or welding goggles with a #10 shade or darker. Welding screens should be used to shield those working nearby. **NEVER LOOK AT A WELDING ARC WITHOUT PROPER EYE PROTECTION.**

Welding “spatter” can travel up to 40 feet in all directions, be sure that there are no combustible materials in the area and that others working nearby are wearing clothing that will protect them from hot spatter. It is recommended that you wear a welder’s cap or bandanna under your welding helmet to protect the top of your head from flying metal.

<p>WELDING HAZARDS</p> <p>Intense Heat</p> <p>Ultra Violet Radiation</p> <p>Flying Debris “Spatter”</p> <p>Fumes</p> <p>Electric Shock</p>
--

Fumes are a hazard whether working inside or outside. The smoke produced during arc welding can cause throat and nose irritation, dizziness, and nausea in addition to carrying small particles deep into your lungs. In confined spaces shielding gas can overwhelm the atmosphere causing dangerously low oxygen levels that can result in suffocation. Fumes generated during welding must be

vented when working inside, and when working outside the welder should position him/herself out of the path of fumes and smoke. Coatings on metals and certain metals themselves can become toxic when heated. Always remove paint and other coatings before welding. **NEVER WELD GALVANIZED METAL.**

The short circuit used to weld exposes the welder and those nearby to the risk of electric shock. Work must be correctly grounded, do not make direct contact with live parts of welding equipment, and do not weld or stand on wet surfaces.

DO NOT WELD OUTSIDE IN RAINY OR WET WEATHER!

- A Auto Darkening Welding Helmet
- B Standard Welding Helmet
- C Welding Goggles
- D Gloves
- E Cotton Welding Jacket
- F Leather Welding Jacket
- G Welder’s Cap
- H Closed-toe Shoes with Rubber Soles
- I Spats (for use with fabric or low-cut shoes)
- J Leather Apron



Metal Shop Equipment

Electric Welders

The welding process generates intense heat, UV radiation, flying debris, and potentially harmful fumes. Appropriate PPE must be worn at all times when welding. Ventilation must be positioned in a way that it will capture smoke and fumes as close to their source as possible. Welding screens should be used to protect others from UV radiation and spatter.

NOTE: ALL WELDERS HAVE DUTY CYCLES, MEANING FOR EVERY 10 MINUTES THAT THE MACHINE IS ON THERE IS A PERIOD THAT YOU CAN WELD AND A PERIOD THAT THE MACHINE MUST COOL. DUTY CYCLES VARY DEPENDING ON MACHINE AND SETTINGS. DO NOT WORK BEYOND DUTY CYCLE LIMITATIONS.

For example; the 140amp MIG welder has a 20% duty cycle when set at 19.5 volts, this means that you can weld for 2 minutes out of every 10 minutes the machine is on. The 250amp MIG welder has a 100% duty cycle at that setting so it can weld for 10 minutes continuously. Studio personnel are available to assist with understanding machine limitations and selecting the correct machine for the task.

AC-DC Arc Welder

Configuration - Welding generator with electrode clamp on 1 lead and work clamp on another lead

Welder Type - Stick

Adjustments - AC, DC+, DC- change when machine is off only
- 30-250 amps DC
- 30-300 amps AC
- Do not make amperage adjustments while welding



Safety

- **Wear welding helmet/goggles with #10 shade or higher**
- **Gloves, long sleeves, long pants, closed-toe shoes required**
- **Shield others from arc and spatter with welding screens**
- **Position ventilation near welding site**
- **Do not weld on wet floors or with wet gloves**
- **Do not touch live tables, tools, or work with bare hands while welding**
- **Do not weld painted or galvanized metal**
- **Remove combustible materials from the area**

DC TIG/Arc Welder

Configuration - Portable welding generator with electrode clamp on 1 lead and work clamp on another lead

Welder Type - Stick (normal configuration)
- TIG welding with proper accessories and shielding gas

Adjustments - DC+, DC- Studio Manager must change polarity
- 0-200 amps DC
- Do not make amperage adjustments while welding

Safety

- **Wear welding helmet/goggles with #10 shade or higher**
- **Gloves, long sleeves, long pants, closed-toe shoes required**
- **Shield others from arc and spatter with welding screens**
- **Position ventilation near welding site**
- **Do not weld on wet floors or with wet gloves**
- **Do not touch live tables, tools, or work with bare hands while welding**
- **Do not weld painted or galvanized metal**
- **Remove combustibile materials from the area**
- **Weld outside when possible**



250 Amp MIG Welder

Configuration - Welding generator with wire-fed welding gun and work clamp
- Shielding gas: Argon/CO² (set to 28psi)

Welder Type - Metal Inert Gas (MIG)

Adjustments - voltage, 10-28.5 volts
- wire feed speed, 50-700 inches per minute
- Do not make voltage adjustments while welding

Safety

- **Stand to the side of pressure regulator when opening gas cylinder**
- **Wear welding helmet/goggles with #10 shade or higher**
- **Gloves, long sleeves, long pants, closed-toe shoes required**
- **Shield others from arc and spatter with welding screens**
- **Position ventilation near welding site**
- **Do not weld on wet floors or with wet gloves**
- **Do not touch live tables, tools, or work with bare hands while welding**
- **Do not weld painted or galvanized metal**
- **Remove combustibile materials from the area**



140 Amp MIG Welder

Configuration - Welding generator with wire-fed welding gun and work clamp
- Shielding gas: Argon/CO² (set to 28psi)

Welder Type - Metal Inert Gas (MIG)

Adjustments - voltage, 10-33 volts
- wire feed speed, 50-500 inches per minute
- Do not make voltage adjustments while welding



Safety

- **Stand to the side of pressure regulator when opening gas cylinder**
- **Wear welding helmet/goggles with #10 shade or higher**
- **Gloves, long sleeves, long pants, closed-toe shoes required**
- **Shield others from arc and spatter with welding screens**
- **Position ventilation near welding site**
- **Do not weld on wet floors or with wet gloves**
- **Do not touch live tables, tools, or work with bare hands while welding**
- **Do not weld painted or galvanized metal**
- **Remove combustible materials from the area**
- **Weld outside when possible**

Torches

The 3D Studio has several torches for heating, cutting, brazing, and welding metal. Torches are available for use only during monitored studio hours under the supervision of studio personnel or class instructor. Special care must be taken when working with pressurized gasses and open flames.

TORCH SAFETY

- **Be sure that all flammable materials are removed from the area.**
- **Locate fire extinguishers and make sure access to them are not blocked.**
- **Turn localized ventilation on, or work outside when possible.**
- **Only work on metal or brick-topped tables. DO NOT HEAT CONCRETE DIRECTLY WITH FLAME**
- **Only move tanks with appropriate carts, tanks must be secured by a chain or clamp.**
- **Check that gas is not leaking from regulators, hoses, or fittings before lighting.**
- **Be sure there are no kinks in hoses or objects on top of hoses. Do not stand on hoses.**
- **Keep hoses out of walkways.**
- **Only light torches with a flint striker DO NOT USE A FLAME TO LIGHT.**
- **Always point the torch away from you and others.**
- **Do not touch the torch with bare hands after it has been lit.**
- **Make adjustments to flames slowly, if the flame blows out close all valves and begin again.**
- **When finished turn off flame and close gas cylinders, then bleed hoses and loosen regulator valves**
- **Wrap hoses neatly and loosely to avoid weakening the rubber with sharp bends.**

Oxygen-Acetylene Torch

STRICTLY OFF LIMITS WITHOUT MANAGER TRAINING AND SUPERVISION

- Configuration - 2 gas cylinders 1 containing fuel (acetylene) and 1 containing pure oxygen are connected to a torch body by a double hose, the flow of the gasses are controlled by regulators on each tank.
- Torch heads can be changed for different processes



- Uses
- Cutting
 - Welding
 - Heating for bending
 - This torch cannot be used for soldering

- Adjustments
- size and intensity of the flame is adjusted with knobs on the torch body
 - Acetylene is adjusted with the knob on the red side of the torch body
 - Oxygen is adjusted with the knob on the green side of the torch body (and with a second knob on cutting heads only)

- Safety
- See torch safety above.
 - Wear appropriate PPE, closed-toe shoes, gloves, apron or welding jacket, welding goggles or face shield with #5 or higher shade.
 - Keep oil away from pure oxygen, pure oxygen will lower the kindling temperature of oil possibly resulting in rapid ignition.
 - Stand to the side of tanks when opening, do not stand in front of regulators. If a regulator was to fail it could shoot the adjusting screw out violently.
 - Open acetylene tank ¼ turn only
 - Direct slag away from others when cutting.
 - Do not set a lit torch down on a table or the ground, extinguish the flame when you need to put the torch down.
 - Wait for metal to cool before sweeping and discarding scraps.

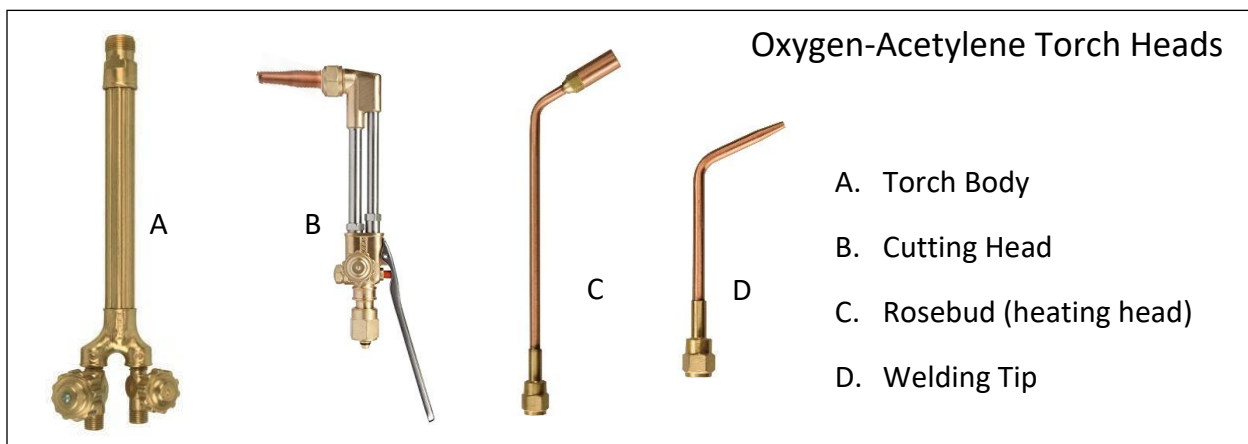

Soldering/Brazing Torch

STRICTLY OFF LIMITS WITHOUT MANAGER TRAINING AND APPROVAL

- Configuration - A torch is connected to a single cylinder of acetylene
- Flow of fuel is controlled with a regulator
 - Oxygen is supplied from the atmosphere



- Uses
- Soldering
 - Brazing
 - Heating/Annealing
 - This torch cannot be used for welding or cutting

- Adjustments
- The fuel is controlled with a single knob on the torch body
 - Oxygen is adjusted by turning a collar at the base of the torch tip

- Safety
- **See torch safety above.**
 - **Wear proper PPE; gloves, closed-toe shoes, goggles or face shield with #5 shade.**
 - **Remove paint and other finishes from metal before heating.**
 - **Open gas ½ turn only.**
 - **Use clamps, bricks, or other means to hold work in place.**
 - **Use tongs to pick up heated metal.**

Large Propane Torch (Weed Burner)

STRICTLY OFF LIMITS WITHOUT MANAGER TRAINING AND APPROVAL

- Configuration - Torch is attached to a tank of propane
- Oxygen is supplied from the atmosphere and is not adjustable

- Uses
- Heating large surfaces
 - Not suitable for heating steel for bending

- Adjustments
- Flame is controlled by a knob on the torch body
 - Allow torch to heat-up for a minute before adjusting to desired flame profile



- Safety
- **See torch Safety Above.**
 - **Wear appropriate PPE; Gloves, Closed-toe Shoes, Safety glasses or face shield.**
 - **ONLY USE OUTSIDE.**
 - **Check for leaks before lighting.**
 - **Keep hose and tank out of line of the flame.**
 - **Have a fire extinguisher or water hose close by.**

Small Propane Torch

Configuration - Small single unit torch body and tip attached directly to a small propane bottle

Uses - Heating small surfaces
- Soldering and brazing

Adjustments - The flame is controlled with a single knob
- Oxygen supply is not adjustable

Safety

- **See torch safety above.**
- **Check for leaks before lighting.**
- **Be sure combustible materials are not in line with the flame.**
- **Do not heat painted or coated metals.**
- **Use exhaust when working inside.**
- **Be sure valve is closed and no gas is escaping when finished.**



Plasma Cutting

Plasma cutting is a process by which a channel of superheated electrically ionized gas is passed through the material to be cut. This generates enough localized heat to melt the base metal while compressed air (the superheated gas) blows the molten metal out of the cut path. The cutting action is very similar to using the oxygen-acetylene torch. By heating a very small area of the base metal this process allows for far more precision than oxygen-acetylene cutting, especially when working with thin metal.

Plasma Cutter

Configuration - A small power unit with a work clamp and torch handle attached to the front of the machine.

Action - Squeezing the trigger on the torch will initiate an arc and flow of plasma, the user follows lines or patterns while keeping the trigger depressed to complete the cut.

Adjustments - Amperage, 20-45 amps
- Select between cutting and gouging

Safety

- **Wear proper PPE, closed-toe shoes, gloves, welding helmet with #10 shade or darker, welding jacket, long pants.**
- **Shield others from UV radiation and sparks with welding screen.**
- **Remove combustibles from the area, be aware of where sparks are falling.**
- **Do not cut painted or galvanized metal.**
- **Position ventilation near the cutting area, or work outside.**
- **Plasma cut metal will remain hot for a long time after cutting, wear gloves when handling metal, and mark pieces as hot so others will not pick them up without gloves.**
- **Do not use the plasma torch in wet conditions.**



Stationary Saws

Many of the saws used to cut metal have the same configuration as those used for wood and function in a similar way. The same hazards posed by radial forces, flying debris, and sharp cutting edges are present when using these tools. In addition, special care should be taken when handling metal after it has been cut. Burs and sharp metal shavings can easily slice skin. Some saws are fitted with abrasive blades that produce sparks and heat metal to high temperatures. For these reasons gloves should always be worn when handling metal after it has been cut.

When cutting metal it is important to reduce friction as much as possible (abrasive blades being the exception where friction is used to make the cut) to ensure safe and accurate cuts. Heat built-up during cutting can cause the metal and the blade to expand slightly causing the blade to bind in the cut, break, or grab and pull the metal potentially along with the user's fingers into the machine. In order to counteract the heat generated by friction slow speeds and lubricants are used when cutting metal.

Horizontal Band Saw

Configuration - Long, continuous band blade looped around 2 large wheels on a single action arm

Cutting Action - Metal is clamped in place and the blade is lowered through it. A continuous flow of cutting fluid is supplied via a pump.

Adjustments - Clamp tilts for beveled cuts 0\45°

Cuts - Straight cuts

Safety

- **Metal must lay flat and be secured by the clamp**
- **NO FREEHAND CUTS**
- **Keep hands and fingers out of the line of cut**
- **Set roller bearings and blade guards as close to the work as possible**
- **Never cut unstable shapes without secondary support (such as a jig)**
The downward force of the blade will twist unstable stock as it cuts, causing the blade to bind, kink, and break.
- **Never force the saw to cut, the weight of the tool is the only force that should be applied to the blade**
- **Support long pieces with saw horses or stock rollers**
- **Keep feet clear of falling stock after being cut**
- **Wait for the blade to stop completely before raising the blade and removing Material**



Vertical Band Saw

Configuration - Long, continuous band blade looped around large upper and lower wheels

Cutting Action - Metal is moved on table into blade
- Lubricant is supplied with oil can

Adjustments - Table top tilts for beveled cuts 0\45°

Cuts - Straight cuts and wide curves
- Rip-cuts, crosscuts, miters, and long radius curves
- Curves are cut freehand
- Crosscuts and miters are cut with miter gauge

Safety

- **Metal must lay flat against table and be held stable.**
- **Keep hands and fingers out of the line of cut, use push sticks when necessary**
- **Take extra care when the blade is exiting the stock.**
- **Never cut round or unstable metal without secondary support (such as a jig).**
- **Set guard no more than 1/8" above metal.**
- **Apply oil to the blade before and during the cut. If oil begins to smoke the blade and metal have become over heated, stop and wait for the material to cool before proceeding.**
- **Never force a curved-cut tighter than allowed by the blade width.**
- **Back out of short cuts slowly with the motor running, stop and realign the cut if the blade pulls with the metal.**
- **Stop the saw to back out of long cuts (over 6"). Backward pressure can cause the blade to jump its guides, hang up, and break.**

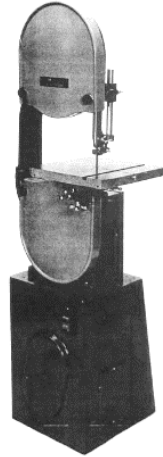

Cut-Off Saw

Configuration - Circular abrasive blade mounted on single action arm

Cutting Action - Blade swings down in chopping motion
- Metal is held in place with a clamp while blade is moved

Adjustments - Clamp swivels for miter cuts 0-45°

Cuts - Crosscut and miters in pipe, tubing, and bar stock

Safety

- **Firmly affix metal with clamp NEVER CUT FREEHAND.**
- **Slow steady feed: DO NOT TRY TO CUT TOO QUICKLY.**
- **Be aware of sparks, remove combustible materials from the area.**
- **Do not cut with a damaged blade. If the blade is chipped or a cut binds on the blade it must be replaced before making any cuts. Damaged blades can break apart suddenly throwing debris violently.**
- **Always return saw to its full start position after the cut.**
- **Never "gang cut" Never cut more than one piece at a time.**



Grinders

The stationary grinders in the metal shop are for smoothing and finishing metal. They should not be used for removing large amounts of material. Always hold your work piece securely, and apply light, even pressure, moving the piece constantly. Trying to grind too quickly will result in poor accuracy and sloppy work. Always use the tables and rests, **NO FREEHAND GRINDING ALLOWED.**

The primary danger of stationary grinders is that the users underestimate their hazard because there are no blades. They can however be just as dangerous as saws. **The hazards of stationary grinders include (1) the radial forces of the spinning parts, (2) the abrading power of the sanding surfaces, (3) the fine particles of dust created, and (4) high temperatures generated during grinding.** Stationary grinders have been known to pull out hair by the roots and tear flesh away to the knuckles.

Rules for stationary grinders

- **Never leave grinders running unattended.**
- **Always maintain secure footing around the grinder.**
- **Never wear gloves, loose clothing, jewelry, neckties, or long loose hair near grinders.**
- **Never lean over or reach under running grinders.**
- **Always use tables and tool rests to support work, no free-hand grinding ever.**
- **Never use a grinder with a damaged wheel or disk.**

Bench Grinder

Configuration - 2 grinding wheels attached to a single motor

Action - smooths and shapes metal

Adjustments - Tool rests tilt to various angles

- Safety**
- **Hold metal firmly, always be able to hold work against the tool rest.**
 - **Be sure tool rest is not more than ¼" from the surface of the grinding wheel.**
 - **Never approach from attacking angle.**
 - **Do not use if wheels are damaged or excessively worn unevenly. Alert shop personnel.**
 - **Keep hands away from abrasive surfaces, especially near intake gaps.**
 - **Never grind pieces too small to hold safely.**
 - **Never use gloves or a rag to hold material.**
 - **Keep work moving to wear grinding wheel evenly. Do not over grind in one place.**



20" Disc Grinder

OFF LIMITS WITHOUT MANAGER TRAINING, AND SUPERVISION

Configuration - Large disk mounted to a motor with an adjustable table

Action - Finish grinds and flattens surfaces

Adjustments - Table tilts 0\45°
- Miter gauge can be used

Safety

- **Hold metal firmly with 2 hands, always be able to hold against the direction of grinder.**
- **Never approach from attacking angle.**
- **Do not use if disk is loose or torn. Alert shop personnel.**
- **Keep hands away from abrasive surfaces, especially near intake gaps.**
- **Always use table to support material.**
- **Hold work securely. Loose metal will be thrown violently.**
- **Never grind pieces too small to hold safely.**
- **Heat build-up on work pieces is very rapid. Use jigs or fixtures to hold work when appropriate to prevent burns.**
- **Never use gloves or a rag to hold material.**
- **Use grinding disk on down side, not up side.**
- **Keep work moving. Do not over grind in one place.**



Power Drills

The principle danger of power drill is the loss of control by the operator and the danger of loose material being twisted up onto the bit. Remember, the bit is spinning, creating the hazards of radial forces.

The primary differences between power drills in the metal shop compared to the wood shop is how they are used, rather than configuration. Metal is drilled at a much slower speed when compared to wood or plastic. Drill bits must be kept lubricated with cutting oil while drilling to reduce heat build-up.

Floor Drill Press

Configuration - Overhead drill mounted above adjustable table

Action - Drill bit is mounted in a chuck, which travels up and down on the quill
- Drills holes perpendicular to table

Adjustments - Variable speed
- Table elevation
- Quill can be locked
- Depth stop for setting hole depth

Safety

- **Use only bits appropriate for the material.**
- **Make sure that the bit is tight and straight in chuck.**
- **Remove key from chuck before turning on.**
- **Secure metal, clamping it whenever possible.**
- **Do not drill into metal table.**
- **Place a scrap of wood under work when appropriate to avoid drilling into the table.**
- **Check drill speed: faster for small bits, slower for large bits.**
- **Never use drill bits with sharp center points in the metal shop.**
- **Avoid awkward hand positions in which a sudden slip would cause hand to go into the cutting tool.**
- **Hold work in left hand and operate drill with right hand.**
- **Never wear gloves, neckties, jewelry, loose clothing, or long loose hair.**



Forming and Shearing Tools

The 3D Studio houses several tools for cutting metal by shearing it and for bending metal to form it. These tools are both electric/hydraulic and manually powered. This equipment is useful for cutting straight lines, bending sharp creases, forming consistent radii, and quickly punching holes.

The forming and shearing tools in the 3D Studio are specialized equipment designed for very specific tasks. It is important to use this equipment for only what it is designed and to not exceed capacity limitations discussed in this manual and marked on the equipment. The dangers associated with radial forces are not as serious a concern with the shearing and forming tools in the metal shop. However pinching and crushing hazards are more prominent with this equipment, and dangerous flying debris is likely if proper set-up and operation procedures are not strictly followed.

25 Ton Ironworker

OFF LIMITS WITHOUT MANAGER TRAINING AND SUPERVISION

Configuration - A 2200psi hydraulic pump powers 2 work stations that can be fitted with tooling for a variety of operations.

Action

- Work is secured in the appropriate position for the job and the user engages the hydraulic pump with a foot pedal.
- Metal is punched, notched, sheared, or formed by enormous force exerted by the pump.

Operations

- Punch
- Plate shear
- Rod shear
- Angle iron shear

Capacity

- Capacity varies by operation specifics are posted with the machine.
- STRICTLY ADHERE TO CAPACITY RATINGS

Safety

- **Do not use without specific permission, training, and direct supervision.**
- **Detailed safety protocol is given during training.**
- **Secure loose clothing, jewelry, and hair.**
- **Face shield is required to be worn while using the ironworker.**
- **All guards must be in place and secure (no loose knobs, screws, or bolts).**
- **All adjustments and changes to tooling must be performed by studio manager or approved instructor. IMPROPER SET-UP WILL RESULT IN SERIOUS INJURY OR DEATH.**



Edwards 25 Ton Ironworker Maximum Load Capacities

PUNCH	ROD SHEAR	PLATE SHEAR	ANGLE SHEAR
1" dia. in 5/16" plate Punch diameter must always be equal to or greater than stock thickness	3/4" Round 13/16" Square	1/4" thick x 6" wide	2" x 2" x 1/4" thick

Jump Shear

Configuration - Hardened steel blade mounted to a frame with a single action lever.

Action

- Flat material is inserted under the blade
- The blade is activated by a manually controlled foot lever. The user usually needs to jump on the lever to exert enough force.



Adjustments - Back stop can be adjusted to repeat cut lengths and angles

Capacity - 16-gauge mild steel

Safety

- **Secure loose clothing, jewelry, and hair.**
- **Keep hands clear of moving parts.**
- **Engage clamp before cutting.**
- **Work with a partner to handle heavy or large stock.**

Finger Brake

Configuration - Heavy steel frame with a series of "fingers" form a long clamp mounted to the top and a hinged gate mounted to the front of the machine.

Action

- Flat material is clamped into the machine and the gate is lifted manually to form a crease.



Adjustments

- Individual fingers can be removed to accommodate box shapes and lips.
- The gate can be swung to various angles.

Capacity - 16-gauge mild steel

Safety

- **Secure loose clothing, jewelry, and hair.**
- **Keep hands clear of moving parts.**
- **Work with a partner to handle heavy or large stock.**

Roll Bending Machine

Configuration - 3 rollers mounted in a triangular arrangement to a heavy duty gearbox.

Action - Linear material is fed into the machine while the rollers are turned manually to produce curves of various radii.

Adjustments - Rollers can be changed to accommodate different shaped stock.
- Top roller moves up and down to determine the degree of curve that is formed.

Safety

- **Secure loose clothing, jewelry, and hair.**
- **Keep hands clear of moving parts.**
- **Use stock rollers to support long material.**
- **Work with a partner to handle heavy or large stock.**



Solid Bar Bender

Configuration - Reinforced steel frame with a high-strength pivot point and long lever.

Action - solid bar and strip stock is positioned between movable dies, the long handle is swung to create curved profiles.

Adjustments - Dies can be positioned in various locations on the frame.
- The handle can be swung up to 200°

Safety

- **Secure loose clothing, jewelry, and hair.**
- **Keep hands clear of moving parts.**
- **Use stock rollers to support long material.**
- **Work with a partner to handle heavy or large stock.**



Pneumatic Tools

With the exception being nail guns, all of the pneumatic tools used in the wood shop may be used in the metal shop. It is important that proper bits, cutters, and sanding discs are used for metal working. A die grinder bit made for metal will not be damaged by using it on wood, but a wood carving bit used on metal will be ruined in seconds.

Remember, air hoses use a female fitting that will connect to the male fitting on the tools. Before use of the tool, the tool should be oiled with proper air tool oil. Air pressure is regulated by valves at each hose connection point. The air pressure is set at 90 psi (pounds per square inch), this is appropriate for most tools used in the studio. If you change the pressure for a specific task, be sure to return the pressure back to 90 psi when you are finished. Never exceed 120 psi in the 3D Studio for any reason.

Disc Sander

- Configuration - Handheld high-speed disc sander
- Action - Disc spins at high speed to rapidly remove material
- Disc Requirements - 4 ½" disc with back-up pad
- Discs available for wood, metal, and stone



- Safety**
- **Safety glasses, dust mask, and ear protection are required.**
 - **Sand at proper angle to avoid breaking the disc. Torn discs can throw sharp pieces violently.**
 - **Secure loose clothing, long hair, and jewelry.**
 - **Item in which you are sanding must be properly clamped or held down.**

Die Grinder

- Configuration - Hand held rotary grinder
- Straight shaft and 90° variations
- Action - Uses different bits for many different grinding purposes
- Bit Requirements - Use the proper bit for the material
- Bits are available for wood, metal, and stone



- Safety**
- **Safety glasses, dust mask, and ear protection are required.**
 - **Be aware of body parts near grinding bits.**
 - **Secure loose clothing, long hair, and jewelry.**
 - **Item in which you are grinding must be properly clamped or held down.**

Cut-Off Tool

Configuration - Handheld abrasive disc cutter.

Action - Disc spins at high speed to rapidly remove material



Disc Requirements - 2-7/8" dia. (sometimes labeled 3")

- Safety**
- **Safety glasses, gloves, dust mask, and ear protection are required.**
 - **Do not use chipped or unevenly worn discs.**
 - **Cut at proper angle to avoid breaking the disc. Broken discs can throw sharp pieces violently.**
 - **Make straight cuts only. Binding the disc inside a cut will result in a broken disc and flying debris.**
 - **Secure loose clothing, long hair, and jewelry.**
 - **Be aware of where sparks are falling, remove combustible materials from the area.**
 - **Item in which you are cutting must be properly clamped or held down.**

Media Blaster (sandblaster)

Configuration - Enclosed cabinet with siphon feed spray gun, foot-pedal trigger, and detached air filter.
- Cabinet size 40" x 40" x 30"

Action - Work is loaded into the cabinet, media is sprayed at high pressure through a handheld gun when activated by a foot-pedal



Media - NO SAND ALLOWED
- Glass Bead
- Aluminum Oxide
- There are many more options for blasting media, consult the Studio Manager for help selecting and purchasing the correct media for your project.

- Safety**
- **Be sure access doors are closed and locked. Do not blast with doors open.**
 - **Do not direct blasting media directly at the window, light, or gloves.**
 - **Only operate with the vacuum running**
 - **Never use sand in the blast cabinet. Exposure to airborne free-silica present in construction and play sand will lead to respiratory problems including silicosis an incurable lung condition.**
 - **Never load more than 20 pounds of media into the cabinet.**
 - **Do not exceed 100psi.**

Hand-Held Power Tools

Hazards posed by hand-held power tools in the metal shop include those introduced by radial forces as well as exposure to blades and cutters, airborne dust and debris, and loss of control due to loss of grip and/or footing. Additionally, some operations produce sparks and heat work pieces rapidly. Appropriate PPE must be worn at all times and work areas must be suitably free of combustible materials.

Before connecting a hand-held power tool to a power source inspect the tool for damage to grinding/cutting discs, blades, guards, housings, and power cords. If damage is found, or the tool malfunctions stop using it immediately and report it to studio personnel or class instructor. To avoid accidental start-up, be sure that power switches are in the off position before plugging tools into a power source. Do not obstruct walkways with power cords.

4 ½" Angle Grinder

Configuration - Handheld high-speed disc grinder

Action - Disc spins at high speed to rapidly remove material

Disc Requirements - 4 ½" disc

- Back-up pad required for sanding discs
- Discs available for wood, metal, and stone

Safety

- **Safety glasses, gloves, dust mask, and ear protection are required.**
- **Grind at proper angle to avoid breaking the disc. Broken discs can throw sharp pieces violently.**
- **Do not use chipped or unevenly worn discs.**
- **Do not use without guard in place.**
- **Secure loose clothing, long hair, and jewelry.**
- **Be aware of where sparks are falling, remove combustible materials from the area.**
- **Grind outside whenever possible.**
- **Item in which you are grinding must be properly clamped or held down.**



7" Angle Grinder

Configuration - Handheld high-speed disc grinder

Action - Disc spins at high speed to rapidly remove material



Disc Requirements - 7" disc

- Back-up pad required for sanding discs
- Discs available for wood, metal, and stone

Safety

- **Safety glasses, gloves, dust mask, and ear protection are required.**
- **Grind at proper angle to avoid breaking the disc. Broken discs can throw sharp pieces violently.**
- **Do not use chipped or unevenly worn discs.**
- **Do not use without guard in place.**
- **Secure loose clothing, long hair, and jewelry.**
- **Be aware of where sparks are falling, remove combustible materials from the area.**
- **Grind outside whenever possible.**
- **Item in which you are grinding must be properly clamped or held down.**

Common Angle Grinder Discs

A Aluminum Oxide Grinding Disc
¼" thick
Heavy metal removal

B Cut-Off Disc
1/32"-1/8" thick
Metal cutting

C Flap Disc
Various grits
Metal smoothing/finishing

D Sanding Disc
Various grits
Metal, wood, stone smoothing

E Carbide Carving Wheel
Various grits
Wood shaping

F Diamond Wheel
Various thicknesses and patterns
Stone cutting

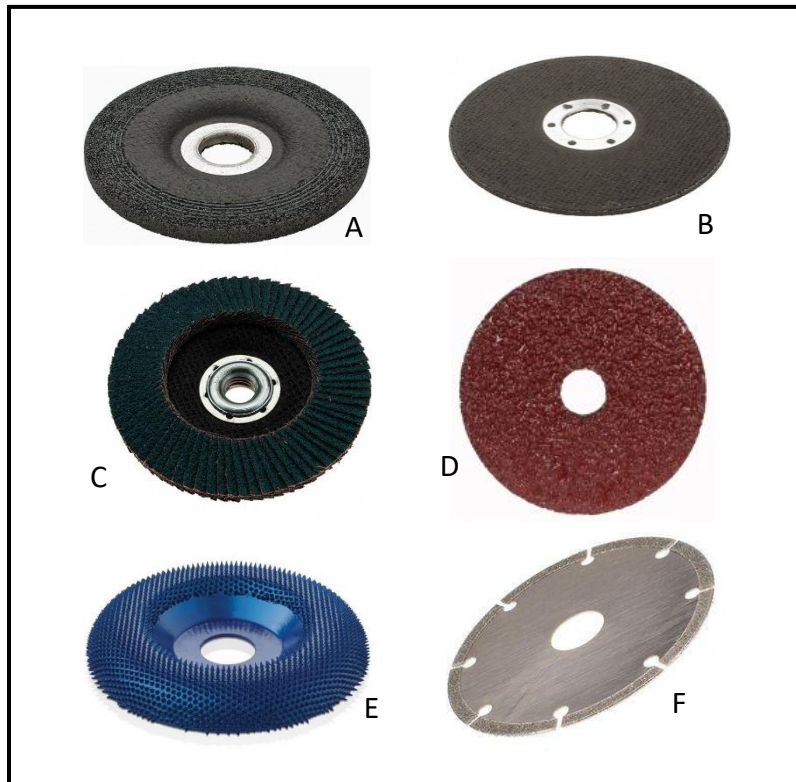

There are many more types of discs that can be used with angle grinders. Students and Faculty are responsible for supplying their own discs. If you have questions about selecting the correct type of disc for your project speak with studio staff or your instructor.

Power Shear

Configuration - Hand held, 3 blade style cutter for mild steel up to 18ga.

Cutting Action - The center blade moves up and down while the operator guides the tool.

Adjustment - Trigger can be locked on
- Speed can be adjusted with trigger

Cuts - Straight or curved cuts in metal up to 18 gauge

Safety

- **Do not exceed tool capacity.**
- **Keep fingers clear of cut line.**
- **Do not cut electrical cord.**
- **Keep electrical cord free of snags.**
- **Secure material before cutting.**



Hand Tools

Hand tools play a very important role in the metal shop. Often final finishing will require the use of hand tools, when hand-held power tools or stationary equipment is too bulky or aggressive to produce the desired results hand tools are the best option. The 3D Studio maintains an extensive inventory of hand tools, the following those that are most commonly used in the metal shop.

Cutting Tools

Hand Saws - The hand saw should be used any time a power tool would be difficult or dangerous to use. Similar to in wood working, a hand saw used correctly will produce efficient, precise cuts. Although when used incorrectly, the hand saw will result in wasted labor and sloppy results.

Hack Saw

Uses - General cutting of most metals and plastics.

Adjustments - Blade is held under tension and should be checked periodically when making many cuts

Action - Cuts on the push stroke



Jeweler's Saw

Uses - The very thin blade allows for precise intricate cuts in metal, plastics, and hard woods

Adjustments - Blade is held under tension and should be checked periodically when making many cuts. When the blade is plucked it will emit a high pitched "ping" if properly tensioned.

Action - Cuts on the pull stroke



Snips - Metal snips are the ideal tool for cutting thin metal. Functioning like a scissors, metal snips allow for straight and curved cuts. There are several variations to metal snips and each variation is designed for a specific type of cut.

- A General Cutting
- B Aviation radius curving to the left
- C Aviation radius curving to the right
- D Aviation straight



Pipe Cutter - A pipe cutter is an excellent tool to use when precise square cuts are needed in pipe and tubing. This is especially true with thin walled tubing and soft metals like copper and brass. The pipe cutter is configured with a single circular hardened steel blade and two adjustable rollers mounted to a frame. Rollers are adjustable to accommodate different sized pipe and tubing and to maintain pressure on the blade during cutting.



To use mark where you want to make your cut and put the edge of the blade on that mark. Next, using the knob tighten the rollers on the pipe and twist the tool around the pipe. After one twist tighten the rollers a ¼ turn and twist again. Repeat this step until the cut is complete. Some deformation of the pipe end will occur, this can be repaired with a reamer or file.

Shaping Tools

Files – Whether you are fitting parts to be welded or putting the final touches on your project, files play a critical role in any metal working job. A file is a piece of hardened steel of varying size and shape with a series of very sharp teeth cut into its face. The size, shape, and pattern of its teeth determine the file's function. Single cut files will produce very fine finished surfaces, while double cut files are for faster removal of material. When well-maintained and used properly files will produce fine surfaces with minimal effort. Conversely, when used incorrectly or poorly treated files will do next to nothing and frustrate the user quickly.

Holding a File

Files will either have a permanently attached handle or a tang on the back end that can be inserted into a removable handle. When a lot of filing is to be done it is best to use a handle to minimize fatigue. Slide the tang into the hole on the handle and press it in firmly. Holding a file with two hands is advisable whenever possible. Use your dominant hand to hold the handle or tang and use your other hand to lightly hold the point of the file for guidance.

Using the File

Files can not be resharpened so to achieve a long useful life for the tool it is important that they be used correctly. All the cutting edges on a file face one direction and are configured to cut on the push stroke. Therefore dragging a file back and forth does not increase the speed at which a part is smoothed and will eventually dull the file. With slight downward pressure push the file with the hand on the handle using your other hand only for guidance. At the end of the stroke lift the file, bring it back to the starting position, then make the next stroke.

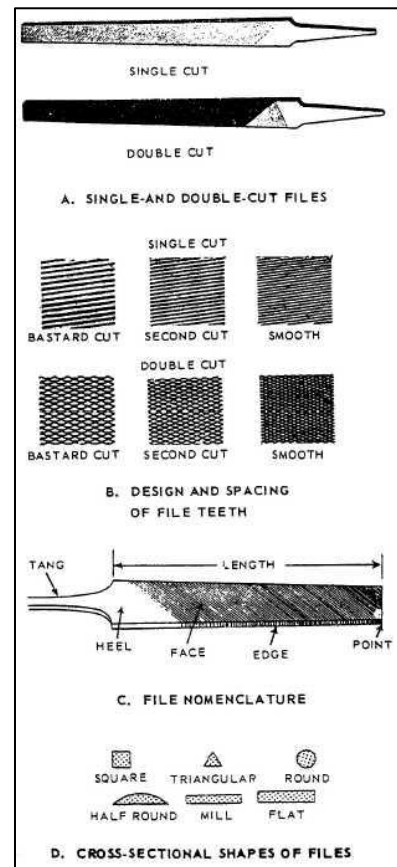

Maintenance

Properly using and maintaining a file will extend its life significantly. Keep files dry, rust will ruin cutting edges. To minimize contamination that can cause oxidation due to electrolysis, files used for ferrous metals should not be used with non-ferrous metals and vice versa. Files used with aluminum or copper occasionally become clogged. Do not use a wire brush to clean, rather use a sharp piece of copper to pick material out from between the teeth.

Cold Chisels - Used for removing welding spatter and slag, burs, and small slivers of metal cold chisels are a useful and often overlooked tool in the metal shop. Cold chisels are available in a number of sizes from very large for heavy material removal to very small for light delicate work.

Cold chisels distinguish themselves from those used for wood by having no separate handle and a double beveled cutting edge.

Cold chisels are struck on the butt end with a metal hammer or mallet. If deformation of the butt end occurs (commonly called mushrooming) this should be ground smooth before continuing to use the chisel.



Pin, Drift, and Center Punches - These tools are used for a number of purposes from removing and aligning parts, to smoothing and texturing surfaces. Pin punches come in a variety of sizes and have a straight shaft and flat end, they are useful for removing dowels and pins. Drift punches have a tapered shaft and flat end, these are used to align parts by sliding the tool through two or more holes and allowing the taper to move parts into proper position. Center punches have a straight or tapered shaft ending at a sharp point. These are used to mark metal or wood for drilling.

Aside from these functions, punch ends can be shaped for the purpose of smoothing or texturing metal. Check with studio staff before modifying punch ends.



Pin Punches



Drift Punch



Center Punch

Tap and Die Set - The tap and die set is used to make threaded parts and connections. The tap is used to cut threads on the female side of a connection and the die is used to cut threads on the male component.

Good results are dependent on several factors, first and foremost is patience. Take your time to mark and clamp or secure your parts well. If tapping holes, drill carefully and be sure to use the correct size drill bit for the threads to be cut. If threading a rod, secure it well in a vise and clean any rust, paint, or dirt from its surface.

All threading operations require cutting oil except when working with cast iron. Apply oil to all cutting surfaces before and during operation. Work slowly to maintain accuracy and avoid breaking the cutter (this is especially important when tapping deep or small holes).

Taps and dies are labeled with the screw diameter and pitch or number of threads per inch (tpi). For example, 1/4-20 means a 1/4" diameter screw with 20 threads per inch. Cutters are available for both imperial and metric sizes, there is a gauge included in the set for determining pitch.

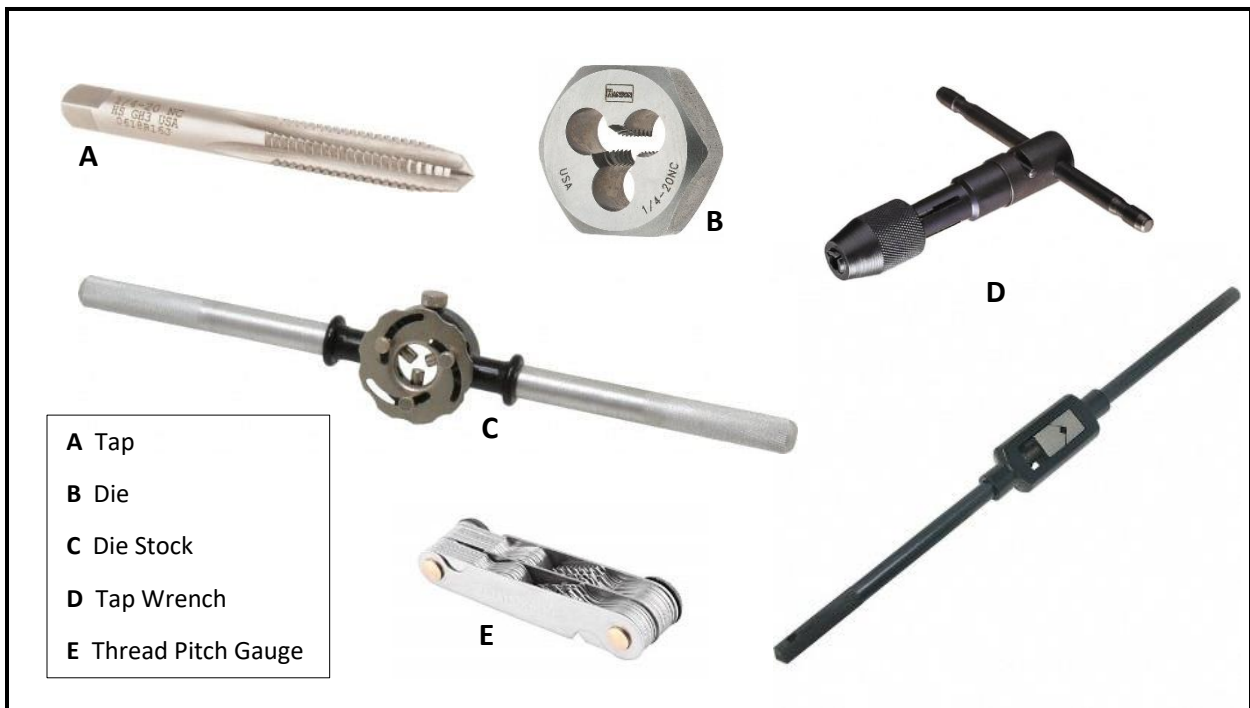

Stone Studio

ALL STONE AND CONCRETE WORK MUST BE DONE OUTSIDE IN THE 3D STUDIO COURTYARD

The stone studio in the 3D Studio is equipped for cutting, carving, and finishing various types of stone. Additionally, equipment is available for the mixing, casting, and working of concrete. The tools and equipment used in the stone studio pose many of the same safety risks as those in other areas in the 3D Studio with some additional hazards. Most notably, exposure to hazardous dust and working with heavy materials.

This space is not included in the 3D Studio Safety Orientation. Students and faculty interested in using the stone studio must complete training with the Studio Manager, or an instructor authorized by the Studio Manager to provide training.

Stone Studio Equipment

Dust Collection

Dust control and collection is an important safety concern for many operations while working with stone. Many types of stone contain high levels of silica that can become airborne and inhaled by workers and those in close proximity to the dust producing operation. Silica dust when inhaled settles in the lungs and can not be absorbed by the body or expelled in any way. Prolonged exposure to silica can result in the medical condition Silicosis, an incurable condition that can cause life-long breathing difficulties as well as other complications. It has been determined by UNCC Department of Environmental Health and Safety that the cutting, grinding, and drilling of stone poses the greatest risk to students and faculty engaged in stone work. The best way to mitigate this risk in the 3D Studio is to collect the dust at its source with portable dust collectors with HEPA filters installed.

PPE and Dust Control For All Power Cutting, Grinding, Sanding, and Drilling

- Full Face-shield
- Dust mask
- Glove
- Ear Protection
- Portable dust collector intake positioned as close to the dust generating operation as possible

- **Reposition the filter intake as needed always keeping as close to the dust source as possible**
- **If suction is weak alert instructor or shop staff DO NOT CONTINUE WORKING UNTIL THE ISSUE IS RESOLVED**



Pneumatic Tools

Pneumatic tools play an important role in stone work. The absence of an electric motor makes them well suited for an environment filled with heavy abrasive dust. Additionally, the ability to finely control speeds and power with the adjustment of air pressure often gives pneumatic tools an advantage over electric powered tools when delicate work is to be completed. **It is very important that pneumatic tools be oiled frequently before, during, and after use.** This will ensure moving parts do not become bound up with accumulated dust or corrosion.

Disc Sander and Die Grinders

Use - For light to moderate material removal and smoothing

Requirements - Use only bits and discs labeled for masonry or stone
- 4 ½" disc with back-up pad for sanding

Safety - **Safety glasses, dust mask, and ear protection are required.**
- **Do not use broken or damaged discs or bits.**
- **Sand at proper angle to avoid breaking the disc. Torn discs can throw sharp pieces violently.**
- **Secure loose clothing, long hair, and jewelry.**
- **Item in which you are sanding must be properly clamped or held down.**



Wet Polisher

Configuration - High speed spindle attached to a body with interchangeable polishing pads and input for water supply

Action - The polishing disc spins rapidly while a continuous flow of water keeps disc and material cool and lubricated

Adjustments - Variable speed settings
- Polishing pads are attached by hook and loop (Velcro)

Safety - **Secure loose clothing, jewelry, and hair.**
- **Always use with guards in place.**



Pneumatic Hammer

Configuration - Handheld piston used for carving with specially designed chisels



Action - When air is supplied, an internal piston continuously moves back and forth striking carving tools when inserted

Adjustments - Speed is adjusted by restricting air flow with a gate valve attached to the air supply hose
- Various shaped and sized chisels are available
- Only use chisels with a round 1/2" shank

Safety - **Safety glasses, gloves, dust mask, and ear protection are required.**
- **Do not use without gloves, the continuous vibration from the tool will form painful blisters on your hands quickly.**
- **Do not use chipped or bent chisels**
- **Do not use without guard in place.**
- **Take frequent breaks to reduce fatigue and damage to hand and wrist joints.**

Common Chisels for Pneumatic Hammers



Point – For marking and roughing out



Tooth – For rough shaping



Bushing – For initial smoothing and texturing



Carving – For refining surfaces and fast material removal



Cleaning Out – For smoothing and refining surfaces, light to moderate material removal



Marble Chisel – Same function as cleaning out chisels but a lighter more delicate tool for softer stones

- These are the common types of chisels. Configuration of teeth and contours of cutting edges vary.
- Note the shape of the shank on these chisels. Any chisel with this shaped shank should not be struck with a mallet

Cutting and Smoothing

4 ½" Angle Grinder

Configuration - Handheld high-speed disc grinder

Action - Disc spins at high speed to rapidly remove material

Disc Requirements - 4 ½" disc

- Back-up pad required for sanding discs
- Only use diamond cutting wheels and grinding discs labeled for masonry

Safety

- **Safety glasses, gloves, dust mask, and ear protection are required.**
- **Grind at proper angle to avoid breaking the disc. Broken discs can throw sharp pieces violently.**
- **Do not use chipped or unevenly worn discs.**
- **Do not use without guard in place.**
- **Secure loose clothing, long hair, and jewelry.**
- **All grinding and cutting of stone must be done outside.**
- **Item in which you are grinding must be properly clamped or held down.**



7" Angle Grinder

Configuration - Handheld high-speed disc grinder

Action - Disc spins at high speed to rapidly remove material

Disc Requirements - 7" disc

- Back-up pad required for sanding discs
- Only use diamond cutting wheels and grinding discs labeled for

Safety

- **Safety glasses, gloves, dust mask, and ear protection are required.**
- **Grind at proper angle to avoid breaking the disc. Broken discs can throw sharp pieces violently.**
- **Do not use chipped or unevenly worn discs.**
- **Do not use without guard in place.**
- **Secure loose clothing, long hair, and jewelry.**
- **All grinding and cutting of stone must be done outside.**
- **Item in which you are grinding must be properly clamped or held down.**



Drilling and Boring

Drilling and boring holes in stone and masonry require drills and bits designed for the material. All drilling in stone must be done with hand-held drills, the drill presses in the 3D Studio may not be used for masonry.

Hammer Drill

Configuration - Hand-held drill

Action - Work is secured and drill moved by hand
- Percussive “hammer” action for hard masonry and stone

Adjustment - Trigger can be locked on
- Speed can be adjusted by varying pressure on trigger
- Forward and reverse directions
- Hammer action can be turned on and off

Safety - **Do not drill “blind”. Do not drill without ascertaining backside of work is clear of obstructions.**
- **Secure loose clothing, jewelry, and long hair.**
- **Do not drill into tabletop or support.**
- **Keep electrical cord free of snags.**
- **Use both hands on drill. If the bit binds up, the drill will try to wrench itself violently from your grip.**
- **Do not use compressed air to clear dust from holes, use water from the hose instead to avoid airborne dust.**



Masonry Drill Bit

SDS Hammer Drill

Configuration - Hand-held drill/ demolition hammer

Action - Percussive “hammer” action for hard masonry and stone

Adjustment - Trigger can be locked on
- Speed can be adjusted by varying pressure on trigger
- Forward and reverse directions
- Drilling action can be turned on and off

Safety - **Do not drill “blind”. Do not drill without ascertaining backside of work is clear of obstructions.**
- **Secure loose clothing, jewelry, and long hair.**
- **Do not drill into tabletop or support.**
- **Keep electrical cord free of snags.**
- **Use both hands. If the bit binds up, the drill will try to wrench itself from your grip. This tool is much more powerful than the hammer drill.**
- **Use dust control procedure mentioned earlier.**



SDS Bit Shank

Hand Tools for Stone Work

Any stone project will employ hand tools to some degree. Like wood and metal work, the hand tools used for stone are designed for a specific function. When well maintained and used properly these tools will efficiently accomplish their task, but when poorly handled and used incorrectly hand work in stone becomes a monumental task that quickly discourages artisans from perusing the craft. When arriving to the point in a project where hand-work takes over from the use of power tools it becomes especially important to practice patience and do not expect the tools to do more than they are capable of, keeping a calm mindset will help you see your project through to completion and work safely while doing so.

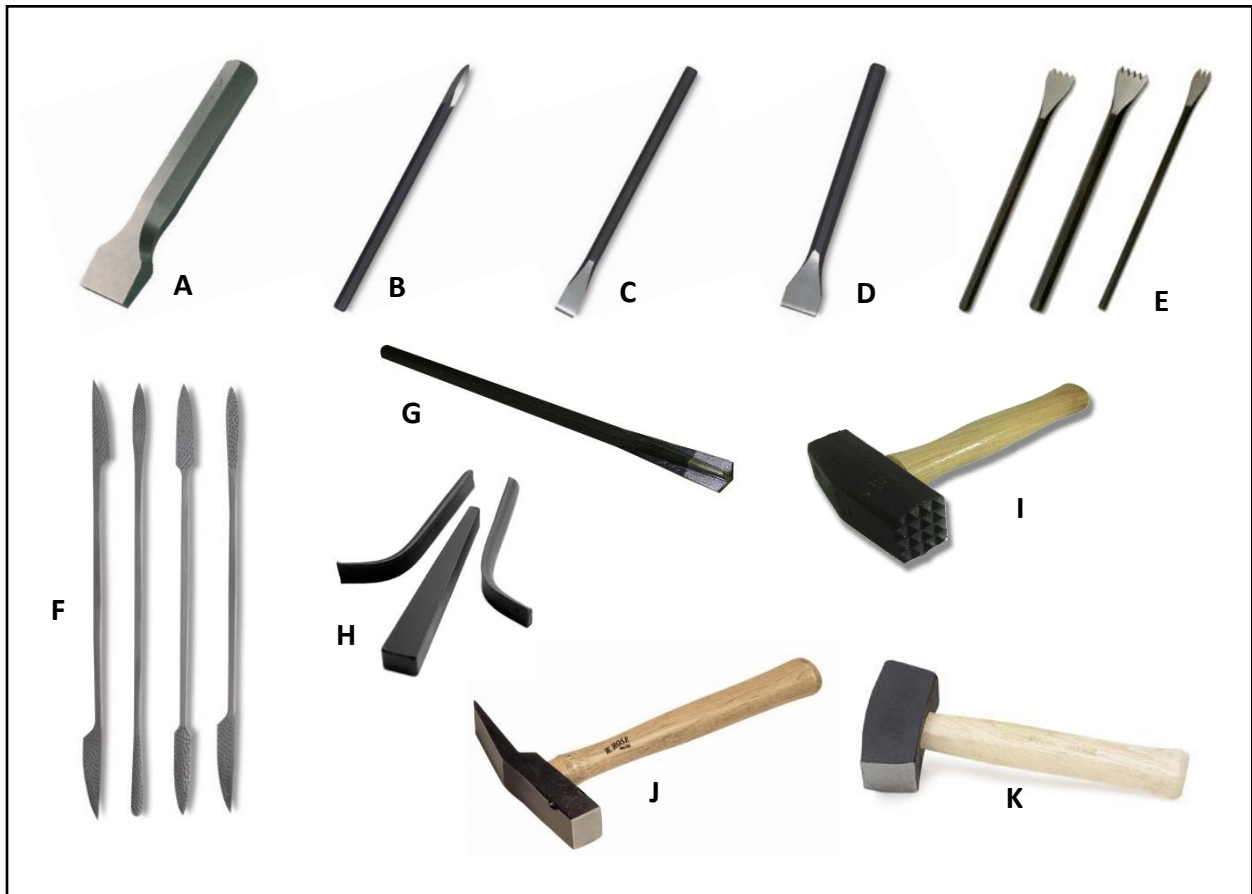

A. Pitching Tool – for removal of large pieces of material **B. Point** – roughing out and marking
C. Flat Chisel – refining surfaces **D. Wide Flat Chisel** – refining and smoothing surfaces
E. Tooth Chisels – rough refinement of forms and surfaces **F. Rasps** – smoothing surfaces
G. Star Drill – for drilling holes by hand **H. Feather and Wedge** – for splitting stone
I. Bushing Hammer – rough surface refinement and texturing **J. Brick Hammer** – for chipping stone
K. Carving Mallet – used to strike carving tools

Concrete

The 3D Studio maintains an inventory of tools and equipment for working with concrete in addition to stone carving. Concrete is a versatile material that can be molded into nearly any shape for a variety of applications. Concrete is a composite material made up of cement and aggregate, when combined with water a chemical reaction takes place that hardens the cement.

When working with concrete it is important to be mindful of the hazards posed by the material. Cement in its powder form and when mixed with water is a caustic substance, it will at very least dry the skin and in some cases, cause severe chemical burns. This effect is significantly diminished after the cement has cured. Always wear gloves, long sleeves, and pants when handling and mixing cement, and wear safety glasses and a dust mask to protect eyes and nasal passages from these effects. When working with the dry components of concrete a dust mask must always be worn. Free silica present in the aggregate will become airborne when mixing cement. Silica exposure is the cause of several respiratory conditions including the incurable silicosis. Free silica is also present when cutting, sanding, and carving cured concrete.

Concrete Mixer

Configuration - A portable carriage holds a large electric motor and rotating drum with mixing blades mounted to the inside.

Action

- Dry components and water are added to the drum, the machine is turned on until the water and dry materials have completely combined.
- The carriage allows for tilting to aid in removing mixed concrete from the drum.

Safety

- **Do not use without specific permission, training, and direct supervision.**
- **Detailed safety protocol is given during training.**
- **Always wear proper PPE.**
- **Keep electrical connections dry.**
- **Secure loose clothing, jewelry, and long hair.**
- **Do not reach into the drum while the machine is running.**



Hand Tools

These are some of the tools available in the studio for mixing and working wet concrete.

ALWAYS WASH AND DRY TOOLS AFTER USE BEFORE CONCRETE HARDENS



Pointing Trowel- used for mixing and moving wet concrete



Margin Trowel - used for mixing and moving wet concrete



Wood and Metal Floats – used for smoothing and finishing wet concrete



Hawk – used to hold small amounts of wet concrete or plaster while working



Jointer – used for finishing edges

Foundry



The Rowe 3D Studio offers students and faculty the ability to cast bronze and aluminum in our foundry located in the 3D Studio Courtyard. The centuries old process allows for the creation of nearly any conceivable shape in a durable material.

Advanced sculpture classes typically pour metal once in the fall and spring semesters. The process of making molds, melting metal, pouring it, then cleaning up and finishing the casts (chasing) is a labor intensive and rewarding effort spread over the course of several days.

Students and faculty interested in using the foundry must meet with the Studio Manager to discuss their project and develop a schedule for completing it. A minimum of 4 people not including the studio manager must be able to participate to arrange use of the foundry. Training on foundry equipment will be provided at the outset of a project. Mandatory safety training and “dress-rehearsal” will be conducted before the day of the pour. **All group members must be present at safety training.**